



# hepo luz



POR LA COMPRA  
DE 1800 €  
DE PEQUEÑO MATERIAL  
EN BLÍSTER

**OBSEQUIO  
DE EXPOSITOR**

**CÓDIGO: 98020**  
Medidas: 95 X 220 cm



Clavija 10A Súper

Código		P.V.
01119	50	0,98
011199	24	1,38
01921	50	0,98
019218	24	1,38



Clavija 10A Súper

Código		P.V.
01113	50	0,98
011137	24	1,38



Base 10A

Código		P.V.
01638	50	1,70
016385	24	2,10
01639	50	1,90
016392	24	2,30



Clavija 16A

Código		P.V.
01344	50	1,30
013445	24	1,70
01348	40	1,30
011052	24	1,70



Base aérea 16A

Código		P.V.
01345	50	1,90
013452	24	2,30
01349	50	1,90
013490	24	2,30



Clavija 16A Sda. Lateral

Código		P.V.
01776	40	1,85
017764	24	2,25



Clavija súper 16A

Código		P.V.
01101	60	2,40
011014	30	2,80



Base aérea súper 16A

Código		P.V.
01115	25	2,80
011151	25	3,20



Clavija 16A Sda. Lateral

Código		P.V.
01775	50	1,75
017757	25	2,15



Clavija súper EXTRA 16A

Código		P.V.
01340	30	1,90
013407	25	2,30



Base aérea súper EXTRA 16A

Código		P.V.
01342	20	2,40
013421	20	2,80



Clavija schucko 16A c/interr.

Código		P.V.
01933	12	4,20
019331	12	4,60



Triple 10A.

Código		P.V.
01098	20	3,30
010987	20	3,80



Triple c/adap.schucko 10A. Pata 4,8

Código		P.V.
01097	20	3,30
010970	20	3,80



Clavija schucko c/interruptor

Código		P.V.
01932	10	3,80
019324	10	4,30

BIPOLAR  
ESPECIAL  
TERMOS



Triple schucko c/prot. niños 16A

Código		P.V.
01483	20	3,80
014831	20	4,30



Doble schucko 16A

Código		P.V.
01482	20	3,40
014824	20	3,90



Triple 1 de 16A. y 2 de 10A.

Código		P.V.
01235	25	2,50
012356	25	3,00



Doble schucko ceramica 16A

Código		P.V.
01312	10	4,20
013124	20	4,70



Triple schucko ceramica 16A

Código		P.V.
01313	10	4,60
013131	20	5,10



Doble schucko 10-16A

Código		P.V.
01488	20	3,90
014886	20	4,40



Triple schucko Sda-Lral c/int

Código		P.V.
01492	20	5,90
014923	20	6,40



Triple schucko Sda-Lral

Código		P.V.
01493	20	5,30
014930	20	5,80



Doble schucko c/ interruptor

Código		P.V.
01935	10	4,40
019355	10	4,90



Intermitente 230V 100W  
Intermitente 230V 500W

Código		P.V.
01050	20	3,10
01051	6	13,20

Código		P.V.
01052	6	24,40

Convertidor de 4 a 4,8 10A

Código		P.V.
01404	50	1,60
014046	24	2,00



Convertidor inglés 16A

Código		P.V.
EX01784	25	2,30

Multi Convertidor 16A

Código		P.V.
01787	25	2,90

Convertidor inglés-Euro 16A

Código		P.V.
01788	25	3,60



Multi Convertidor 16A

Código		P.V.
01699	10	6,60

Convertidor inglés-Euro 16A

Código		P.V.
01728	20	3,10
017283	20	3,50

Multiconvertidor 16A

Código		P.V.
01785	25	2,20
017856	25	2,60



Cargador 2 USB + schucko

Código		P.V.
04002263	6	19,90



Cargador 2 USB c/ 2 tomas  
shucko + toma 10A

Código		P.V.
04002279	6	19,90



Convertidor de viaje BLISTER

Código		P.V.
008046	12	7,30



Base horno empotrar 25A.

Código		P.V.
01555	10	4,90
015531	10	5,30



Base horno empotrar 25A.

Código		P.V.
01554	10	3,90



Clavija horno 25A.

Código		P.V.
01547	10	5,40
015463	10	5,90



Base superficie 16A

Código		P.V.
01389	24	2,70
013896	24	3,10



Base Empotrar 16A

Código		P.V.
01370	24	4,90
013704	24	5,40



Para perfil simétrico de 35mm (carril DIN)

Base para carril 16A. 250V.

Código		P.V.
01392	10	11,90



Blisters 5 piezas

Protector schucko

Código		P.V.
01558	100	0,24
015586	24	1,50



Blisters 5 piezas

Protector schucko

Código		P.V.
01557	100	0,12
015579	24	1,00



Interruotor tirador

Código		P.V.
HL950	10	0,95



Clavija industrial caucho  
16A 250V

Código		P.V.
01743	25	1,80
017436	25	2,20



Clavija goma industrial IP 44  
16A 250V (acepta base francesa)

Código		P.V.
01745	25	2,10
017450	25	2,50



Base industrial caucho  
IP 20 16A

Código		P.V.
01467	20	2,70
014671	20	3,10



Clavija industrial PVC  
IP 44 16A

Código		P.V.
01741	25	1,80
017412	25	2,20



Clavija industrial PVC  
16A 250V. (acepta base francesa)

Código		P.V.
01746	25	2,10
017467	25	2,50



Base industrial PVC  
IP 44 16A

Código		P.V.
01465	20	2,70
014664	20	3,10



Clavija industrial 16A-250V  
Thermoplastic rubber

Código		P.V.
01755	30	2,40
017559	20	2,80



Base industrial IP20 16A-250V  
Thermoplastic rubber

Código		P.V.
01756	10	3,50
017566	10	3,90

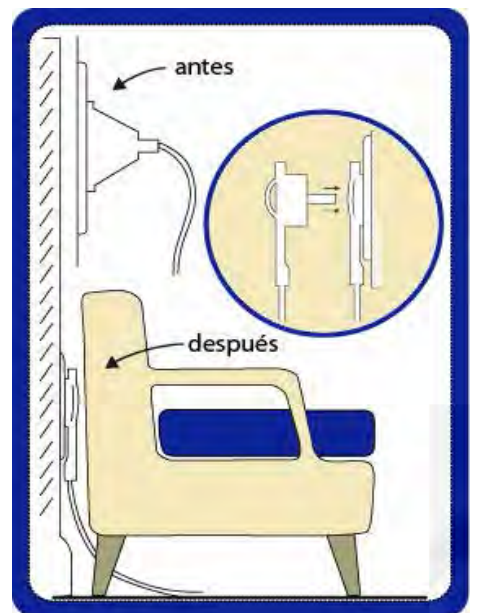

Clavija extraplana transmúeble  
con T/T sda. Lateral 16A

Código		P.V.
01034	12	3,20
01035	12	3,20



COD: 01034



COD: 01035





Triple schucko caucho con tapas 16A 250V

Código		P.V.
01471	5	37,40



Triple schucko con tapas 16A 230V

Código		P.V.
01469	10	19,80
014695	10	20,30



Triple schucko con tapas 16A 230V

Código		P.V.
01470	10	19,80
014701	10	20,30



Base goma industrial con tapa IP 44 16A 240V

Código		P.V.
01468	10	8,40
014688	10	8,90

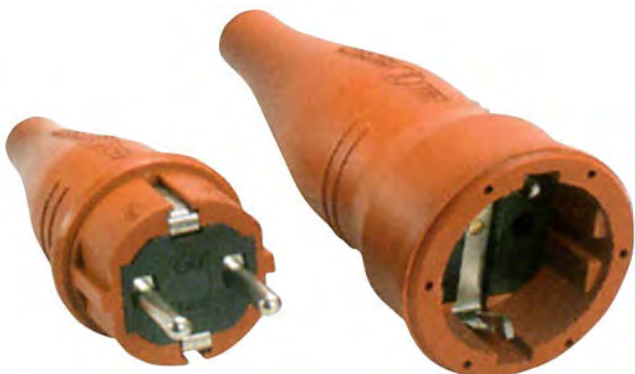

Clavija goma industrial IP 44 16A 240V

Código		P.V.
01410	20	4,70
014107	20	5,20

Base goma industrial IP 44 16A 240V

01415	10	6,80
014152	10	7,30



Clavija goma industrial IP 44 16A 240V

Código		P.V.
01411	20	3,50
014114	20	4,00

Base goma industrial IP 44 16A 240V

01416	10	5,60
014169	10	6,10



Portalámparas latón cadena

Código		P.V.
03202	25	3,90



Portalámparas latón E27

Código		P.V.
03216	20	2,60
032163	24	3,00



Portalámparas cerámico E14

Código		P.V.
03225	50	2,20
032255	24	2,60



Portalámparas cerámico E14

Código		P.V.
03281	40	1,40
032811	24	1,80



Portalámparas cerámico E27

Código		P.V.
03282	24	1,40
032828	24	1,80



Portalámparas cerámico E27 campana

Código		P.V.
03283	24	1,70
032835	24	2,10



Portalámparas cerámico E27

Código		P.V.
03280	50	2,74



Portalámparas cerámico E40

Código		P.V.
03287	6	14,50



Portalámparas rosca cerámico E27

Código		P.V.
03004	24	2,20



Portalámparas cerámico E27

Código		P.V.
03003	20	1,40



Portalámparas cerámico c/tornillos

Código		P.V.
03001 - E14	24	0,90
03002 - E27	20	0,90



Interruptor tirador mueble

Código		P.V.
HL950	10	0,95





Portalámparas obra E27

Código		P.V.
03092	50	1,30
030923	24	1,70



Portalámparas obra E14

Código		P.V.
03091	50	1,20
030916	24	1,60



Portalámparas obra E27

Código		P.V.
03012	50	0,80
030121	24	1,20



Portalámparas obra E27

Código		P.V.
03087	50	0,80
030879	24	1,20



Portalámp. tija 10mm. E14

Código		P.V.
03410	50	1,20
034105	24	1,60
03411	50	1,20
035454	24	1,60



Portalámp. tija 10mm. E27

Código		P.V.
03415	50	1,40
034150	24	1,80
03416	50	1,40
035461	24	1,80



Portalámparas resina E14

Código		P.V.
03420	50	0,90



Portalámparas resina E27

Código		P.V.
03425	50	0,90

Si le quitamos el puente nos valen los portalámparas para todos los proyectores.



Portalámparas focos - completo

Código		P.V.
03812	16	2,60



Portalámp. halógeno GU10

Código		P.V.
03811	50	0,86
038110	24	1,26



Portalámp. halógeno GZ-10

Código		P.V.
03815	50	0,86





Portalámp. halógeno G-6,35

Código		P.V.
03810	50	0,60
038103	24	1,00





Portalámparas liso E27

Código		P.V.
03156	25	2,20
031562	24	2,60
03161 	25	2,20
031616 	24	2,60





Portalámparas liso E14

Código		P.V.
03465	50	1,90
034655	24	2,30
03461 	50	1,90
034617 	24	2,30



Los blísters llevan la arandela



Portalámparas rosca E27

Código		P.V.
03157	25	2,30
031579	24	3,20
03162 	25	2,30
031623 	24	3,20



Los blísters llevan la arandela



Portalámparas rosca E14

Código		P.V.
03466	50	2,00
034662	24	2,85
03462 	50	2,00
034624 	24	2,85



Los blísters llevan la arandela



Portalámp. rosca c/ tope E27

Código		P.V.
03158	25	2,30
031586	24	3,20
03163 	25	2,30
031630 	24	3,20



Los blísters llevan la arandela

Portalámp. rosca c/ tope E14

Código		P.V.
03467	50	2,00
034679	24	2,85
03463 	50	2,00
034631 	24	2,85



Los blísters llevan la arandela

Portalámp. con interrump. E27

Código		P.V.
03165	20	6,40
031654	20	6,90



Portalámparas feria E27

Código		P.V.
03400	50	1,30
034006	24	1,70





Portalámp. Rosca doble arandela E27

Código		P.V.
03159	20	1,90
031593	20	2,30







Arandela portalámparas E27

Código		P.V.
03166	25	0,50
031661	24	0,90
03167 	25	0,50
031678 	24	0,90



Arandela portalámparas E14

Código		P.V.
03469 	50	0,45
034693 	24	0,85
03468 	50	0,45
034686 	24	0,85



Adaptador portalámparas E14 a E27

Código		P.V.
03446	12	2,32
034464	12	2,72



Adaptador portalámparas E27 a E14

Código		P.V.
03472	12	2,32
034723	12	2,72



Adaptador portalámparas E27 a E40

Código		P.V.
03570	20	4,80



Adaptador portalámparas E40 a E27

Código		P.V.
03571	24	2,20
035713	24	2,60



Convertidor de tubo G13 a G10 ( tubo 18W a tubo 14W )

Código		P.V.
03262	12	2,10



Convertidor de tubo G13 a G10 ( tubo 36W a tubo 28W )

Código		P.V.
03263	12	2,10



Adaptador portalámparas E14 A GU10

Código		P.V.
03644	12	3,10
036444	12	3,50



Adaptador portalámparas E27 A GU10

Código		P.V.
03632	12	3,30
036328	12	3,70



Adaptador portalámparas E27 A G53

Código		P.V.
03635	4	4,80
036352	4	5,20



Portal. miñonet puente E10

Código		P.V.
03319	100	0,60
033191	24	1,00

Código		P.V.
--------	---	------

Código		P.V.
--------	---	------



E27

Zócalo orientable E27

Código		P.V.
03336	12	5,90
033368	12	6,40



E27

Zócalo curvo E27

Código		P.V.
03038	25	2,20
030381	25	2,70



E27

Zócalo recto E27

Código		P.V.
03335	25	2,00
033351	25	2,50



E27

Zócalo curvo port.cerámico

Código		P.V.
03040	25	2,40



Adaptador schucko con entrada USB+soporte para teléfono.

Código		P.V.
04002312	10	17,80



Clavija con regulador de luz

Código		P.V.
007939	12	9,90

**Incandescentes**  
de 20 a 300W  
**ó Halógenas**  
de 20 a150W  
**230V - 50hX.**



Clavija Schucko con regulador de luz

Código		P.V.
007938	12	10,60



Interruptor paso 6A.

Código		P.V.
04541	50	2,60
045415	24	3,10



Interruptor paso 6A.

Código		P.V.
04708	40	1,40
047082	24	1,90



Interruptor paso 6A.

Código		P.V.
04709 BL/RJ	60	1,40
047099	24	1,90
04710 NG/RJ	60	1,40
047105	24	1,90



Interruptor paso 2,5A. **BIPOLAR**

Código		P.V.
04231	50	1,90
042315	24	2,40
04232 	50	1,90
042322 	24	2,40



Interruptor pie 6A

Código		P.V.
04249	25	3,30
042490	24	3,80



Interruptor flexo 2A

Código		P.V.
04234	100	0,70
042346	24	1,10



Interruptor panel

Código		P.V.
04715	50	1,20

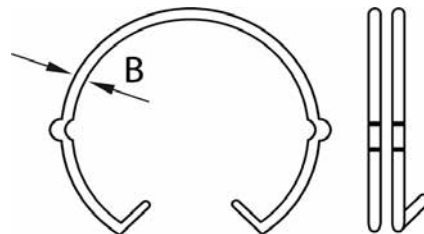

Aro sujeción

Código		P.V.
03823	50	0,30

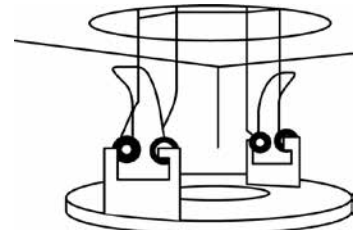

Pinzas aros

Código		P.V.
03821	50	0,40



Portatubo

Código		P.V.
03801	50	1,20
038011	24	1,60



Portacebador

Código		P.V.
03804	50	1,50
038042	24	1,90



Portatubo+cebador

Código		P.V.
03802	50	2,40
038028	24	2,80



**solo exportación · solo exportación · solo exportación · solo exportación · solo exportación · solo exportación**

Base luz

Código		P.V.
EX1506	50	1,70

Interruptor

Código		P.V.
EX6622	50	1,80

Conmutador

Código		P.V.
EX6322	50	2,10



Base serie estrella

Código		P.V.
05210	25	2,40
052109	24	2,90



Interruptor serie estrella

Código		P.V.
05214	25	4,90
052147	24	5,40



Conmutador serie estrella

Código		P.V.
05216	25	5,70
052161	24	6,20



Placa pequeña 75X46, 1 elem.

Código		P.V.
05314	10	1,04



Placa pequeña 75X80, 2 elem.

Código		P.V.
05322	10	1,58



Placa grande 115X80, 1 elem.

Código		P.V.
05355	10	1,60



Placa grande 115X120, 2 elem.

Código		P.V.
05363	10	2,10



Placa grande 115X139, 3 elem.

Código		P.V.
05371	10	2,40



Código	Modelo		Código Blíster	Precio Granel	Precio Blíster
SERIE ESTANCA HEPOLUZ					
05610	Interruptor	10	056107	4,50	5,00
05615	Conmutador	10	056152	4,90	5,40

Doble

05612	Interruptor	10	056121	5,40	5,90
05617	Conmutador	10	056176	5,90	6,40

Pulsadores

05620	Pulsador timbre	10	056206	4,80	5,30
05622	Pulsador con luz	10	056220	4,90	5,40

# IP55

Base luz schucko

05625	16A con T/T	10	056251	5,40	5,90
-------	-------------	----	--------	------	------

**Todos con puerta y membrana de goma**

Doble base luz schucko

05630	16A con T/T	10	056305	9,20	9,90
-------	-------------	----	--------	------	------

Base luz Schucko con interruptor

05635	16A con T/T	10	056350	7,90	8,60
-------	-------------	----	--------	------	------



Código	Descripción		Precio granel
Serie estanca IP54 de superficie			
05701	Conmutador	20	<b>3,90</b>
05703	Pulsador	20	<b>3,80</b>
05702	Doble conmutador	20	<b>5,50</b>
05704	Pulsador C/LUZ	20	<b>4,95</b>
05705	Base schucko	20	<b>3,80</b>
05706	schucko + conmutador	10	<b>8,70</b>
05707	Doble schucko	10	<b>7,70</b>



## Serie Kristal



Código	Modelo		Código Blíster	Precio Granel	Precio Blíster
07065	Interruptor	12	070653	5,80	6,30
07085	Conmutador	12	070851	6,20	6,70
07095	Base luz	12	070950	5,60	6,10
07105	Pulsador timbre	12	071056	6,50	7,00
07155	Base luz Schucko	10	071551	7,20	7,70
07345	Conmutador +Base luz	8	073456	11,90	12,40

# SERIE POLAR

DE SUPERFICIE

COLOR  
BLANCO



Código	Modelo		Código Blíster	Precio Granel	Precio Blíster
Serie Polar					
06602	Interrup.Conm.	30	066021	3,40	3,90
06609	Cruzamiento	30	066090	6,20	6,70

### Pulsadores

06603	Pulsador Timbre	30	066038	3,10	3,60
06604	Pulsador Luz	30	066038	3,10	3,60

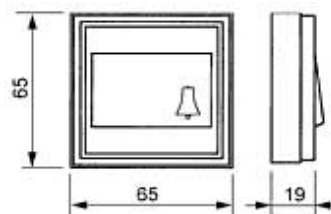

### Doble Conmutador

06610	Blanca	30	066106	4,20	4,70
-------	--------	----	--------	------	------

### Base luz

06607	Blanca	25	066076	3,40	3,90
-------	--------	----	--------	------	------

### Base luz schucko

06661	Blanca	30	066618	3,90	4,40
-------	--------	----	--------	------	------

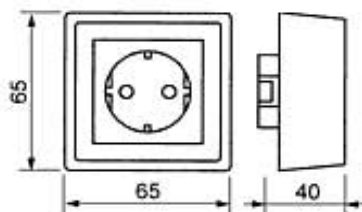

# SERIE LEKA 65

para superficie



Código	Modelo	 Código Blíster	Precio Granel	Precio Blíster
06501	Interruptor	10 065017	1,90	2,40
06503	Conmutador	10 065031	2,60	3,10
06502	Doble interruptor	10 065024	2,90	3,40
06505	Pulsador	10 065055	2,40	2,90
06507	Base 16A con T/T	10 065079	2,30	2,80
06509	Base 10A	10 065093	2,20	2,70
06512	Base TV/FM	10 065123	3,60	4,10
06515	Base teléf. RJ11	10 065154	2,60	3,10

- Medidas del mecanismo con marco 60X60mm.
- Contactos de plata de alto poder de ruptura.
- Mecanismos de 10A 250V- según norma. UNE-EN 60669.
- Grado de protección IP30.

# SERIE LEKA 65

para superficie



Código	Modelo		Precio Solapa
06571	Base superf.	10	<b>2,80</b>
06575	Base + Conmut.	10	<b>5,40</b>
06572	Base 2 tomas	10	<b>4,40</b>
06573	Base 3 tomas	10	<b>5,90</b>
06574	Base 4 tomas	10	<b>7,40</b>

## Serie Lena



Superficie  
y empotrar



Código	Modelo		Código	Precio	Precio
			Blíster	Granel	Blíster
06551	Interruptor	10	065512	1,90	2,40
06553	Conmutador	10	065536	2,60	3,10
06555	Doble Interruptor	10	065550	2,90	3,40
06557	Base 16A C/T/T	10	065574	2,30	2,80
06559	Base 10A	10	065598	1,90	2,40
06561	Base TV	10	065611	1,90	2,40
06562	Base TV/FM	10	065628	2,90	3,40
06565	Base teléfono	10	065659	2,60	3,10

Medidas del mecanismo con marco 80X80X20mm.  
Contactos de plata de alto poder de ruptura.  
Mecanismos de 10A 250V- según norma. UNE-EN 60669  
Grado de protección IP30

# SERIE DE EMPOTRAR LISBOA

**COLOR BLANCO**



Código	Modelo		Código Blíster	Precio Granel	Precio Blíster
08000	Lámpara neón	40		2,70	
08001	Interruptor	10	080010	4,60	5,00
08005	Conmutador	10	080058	5,10	5,50
08007	Cruzamiento	10	080072	8,80	9,20
08008	Interruptor doble	10	080089	6,50	6,90
08009	Conmutador doble	10	080096	8,10	8,50
08011	Pulsador	10	080119	4,70	5,10
08020	Base luz	10	080201	3,90	4,30
08024	Base luz schucko	10	080249	4,40	4,80
08031	Base TV	10	080317	12,80	13,20
	Base Teléfono	10	080409		9,30
08071	Marco 1 elem.	10	080713	1,30	1,70
08072	Marco 2 elem.	10	080720	2,40	2,80
08073	Marco 3 elem.	10	080737	3,60	4,00

# SERIE LISBOA

DE EMPOTRAR

COLOR BLANCO

CON MARCOS Y EN BLISTER



Código Blister	Modelo		Precio €
----------------	--------	---	----------

## SERIE LISBOA PARA EMPOTRAR EN CAJA UNIVERSAL

080416	Interruptor	10	6,40	080508	Doble interruptor	10	12,40
080423	Conmutador	10	6,90				
080430	Cruzamiento	10	10,60	080515	Conmutador + interruptor	10	12,90
080447	Interruptor doble	10	8,30	080539	Conmutador + Base luz schucko	10	12,90
080454	Conmutador doble	10	9,90				
080461	Pulsador	10	6,50				
080478	Base luz	10	5,90				
080485	Base luz schucko	10	6,60				
080492	Base TV	10	14,90				

## Serie Touran

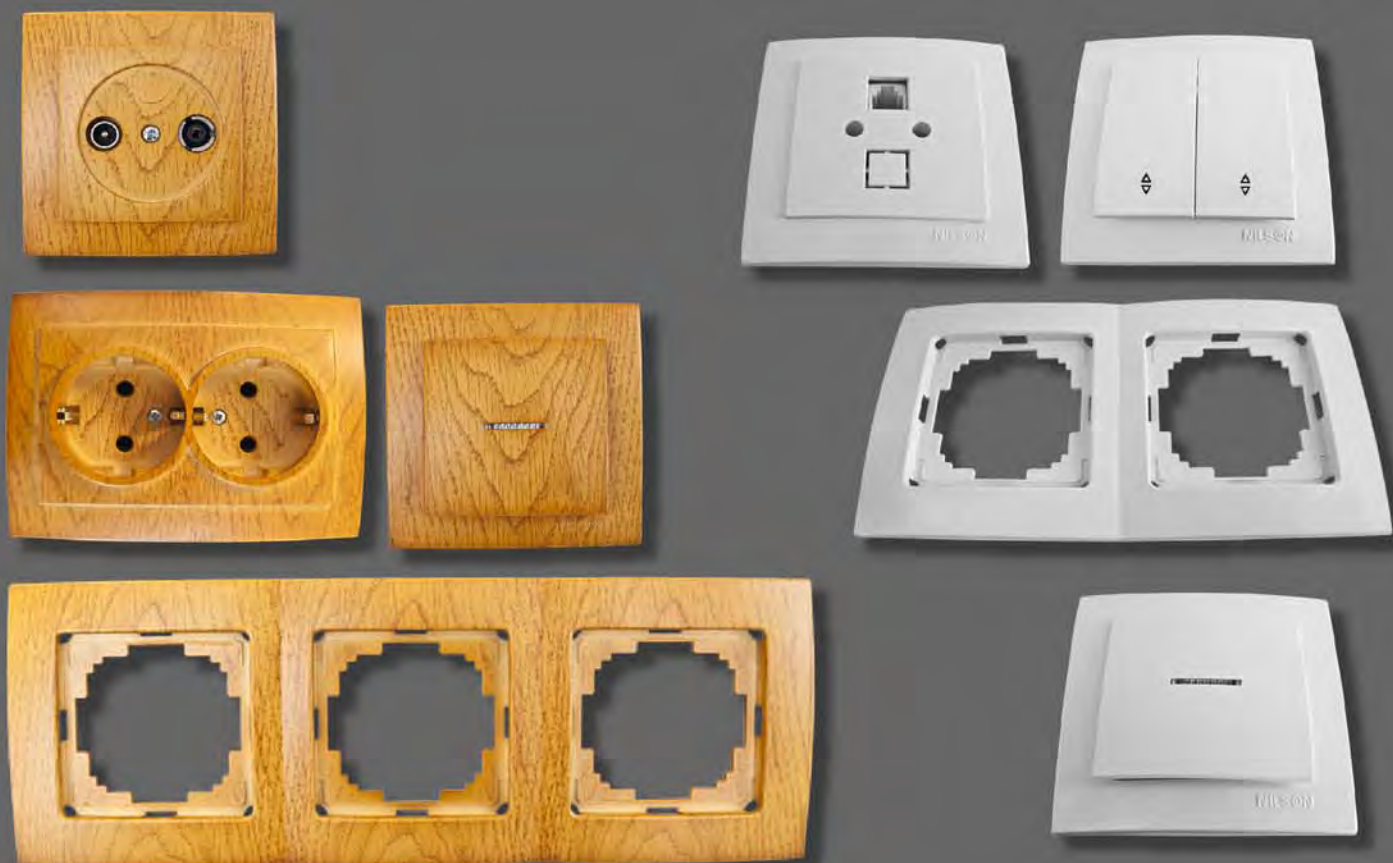

**Blanco nieve**  
**Metálico plata**  
**Madera roble**

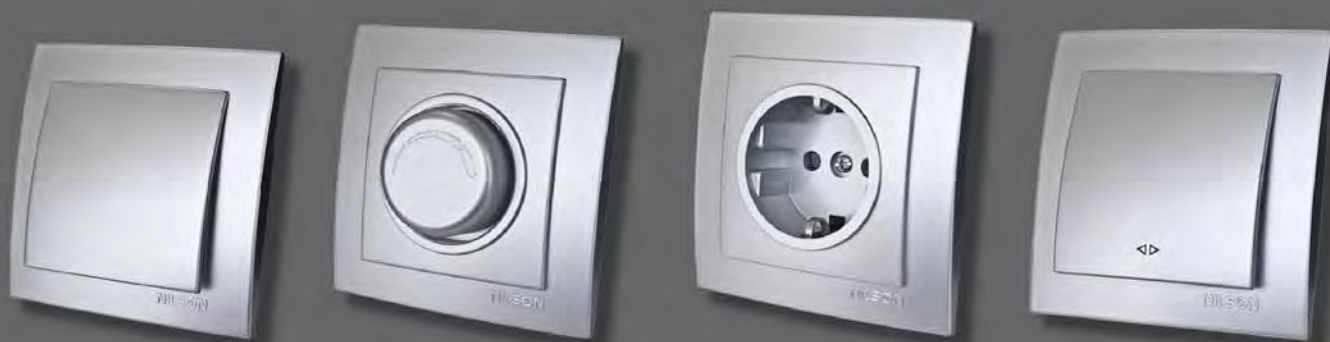





Código		Modelo		Granel	Blíster
				€	€
08101	7	Interruptor	12	3,40	4,00
08103	1	Doble Interruptor	12	3,90	4,50
08105	5	Pulsador	12	3,60	4,20
08106	2	Pulsador con luz	12	4,60	5,20
08107	9	Conmutador	12	3,90	4,50
08109	3	Doble Conmutador	12	5,20	5,80
08110	9	Cruzamiento	12	5,20	5,80
08120	8	Base Schucko	12	4,90	5,50
08125	3	Base Doble Schucko	5	7,20	7,80
08130	7	TV Base alemana	12	17,90	18,50
08131	4	TV Base alemana final	10	17,90	18,50
08140	6	Base teléfono	12	4,50	5,10
08152	9	Potenciómetro 600 W	8	21,90	22,50
08192	5	Marco doble	12	2,20	2,80
08193	2	Marco triple	12	2,60	3,20



Código	Modelo	Granel	Blíster	
			€	€
08201	4 Interruptor	10	6,50	7,10
08205	2 Pulsador	10	6,50	7,10
08206	9 Pulsador con luz	10	7,30	7,90
08207	6 Conmutador	10	7,30	7,90
08209	0 Doble Conmutador	10	8,90	9,50
08210	6 Cruzamiento	10	8,90	9,50
08219	9 Base Schucko	10	8,90	9,50
08225	0 Base Doble Schucko	5	10,80	11,40
08230	4 TV Base alemana	10	19,90	20,50
08231	1 TV Base alemana final	10	19,90	20,50
08240	3 Base teléfono	10	6,50	7,10
08252	6 Potenciometro 600 W	8	21,90	22,50
08292	2 MARCO DOBLE	10	3,90	4,50
08293	9 MARCO TRIPLE	10	4,80	5,40

**DESCUENTO ESPECIAL 45+40%**



Código		Modelo		Granel €	Blistar €
08301	<b>1</b>	Interruptor	10	<b>6,95</b>	<b>7,55</b>
08303	<b>5</b>	Doble Interruptor	10	<b>7,80</b>	<b>8,40</b>
08305	<b>9</b>	Pulsador	10	<b>6,95</b>	<b>7,55</b>
08306	<b>6</b>	Pulsador con luz	10	<b>7,90</b>	<b>8,50</b>
08307	<b>3</b>	Conmutador	10	<b>7,60</b>	<b>8,20</b>
08309	<b>7</b>	Doble Conmutador	10	<b>9,60</b>	<b>10,20</b>
08310	<b>3</b>	Cruzamiento	10	<b>9,40</b>	<b>10,00</b>
08319	<b>6</b>	Base Schucko	10	<b>8,80</b>	<b>9,40</b>
08330	<b>1</b>	TV Base alemana	10	<b>19,90</b>	<b>20,50</b>
08331	<b>8</b>	TV Base alemana fin	10	<b>19,90</b>	<b>20,50</b>
08340	<b>0</b>	Base teléfono	10	<b>6,95</b>	<b>7,55</b>
08352	<b>3</b>	Potenciómetro 600 W	8	<b>29,60</b>	<b>30,20</b>
08392	<b>9</b>	Marco doble	10	<b>5,90</b>	<b>6,50</b>
08393	<b>6</b>	Marco triple	10	<b>7,90</b>	<b>8,50</b>

**DESCUENTO ESPECIAL 45+40%**



Base 2 tomas con T/T

Código		P.V.
09362	10	10,60



Base 3 tomas con T/T

Código		P.V.
09363	10	12,50



Base 4 tomas con T/T

Código		P.V.
09364	5	14,50



Base 3 tomas con T/T

Código		P.V.
09395	10	4,70



Base 3 tomas con T/T+Int.

Código		P.V.
09301	10	5,50



Base 2 tomas Empotrar c/ T/T

Código		P.V.
08125	7	7,20



Base 1 toma súper. con T/T

Código		P.V.
09000	20	2,60



Base 2 tomas súper. con T/T

Código		P.V.
09575	15	9,40



Base 3 tomas súper. con T/T

Código		P.V.
09585	10	11,20



Base 2 tomas con T/T

Código		P.V.
09076	12	2,90



Base 3 tomas con T/T

Código		P.V.
09084	10	3,70



Base 4 tomas con T/T

Código		P.V.
09085	6	4,50



Base 4 tomas con T/T

Código		P.V.
09092	6	5,20



Base 6 tomas con T/T

Código		P.V.
09098	8	14,90



Base 6 tomas con T/T

Código		P.V.
09086	6	6,20



Base 4 tomas con T/T+Int.

Código		P.V.
09088	6	5,40



Base T/T sin cable

Código		P.V.
09089	6	6,90



Protección estanca jardín

Código		P.V.
09660	10	4,60

# SERIE E C O

## BASES MÚLTIPLES

**MANGUERA**  
3G1 MM, Y H05VV-F  
DE 1,5 MTS.



Base 3 tomas T/T 1,5 mts.

Código		P.V.
09208	10	4,40



Base 4 tomas T/T 1,5 mts.

Código		P.V.
09209	10	5,30



Base 5 tomas T/T 1,5 mts.

Código		P.V.
09210	10	5,90



Base 6 tomas T/T 1,5 mts.

Código		P.V.
09211	10	6,60



Base 3 tomas T/T 1,5 mts.+ Int.

Código		P.V.
09222	10	5,80



Base 4 tomas T/T 1,5 mts.+ Int.

Código		P.V.
09223	10	6,60



Base 5 tomas T/T 1,5 mts.+ Int.

Código		P.V.
09224	10	7,20



Base 6 tomas T/T 1,5 mts.+ Int.

Código		P.V.
09225	10	7,70

# Manguera 3x1,5 mm Caja 10



Base 3 tomas T/T

Código	Mts.	P.V.
09303	1,5	5,50
09333	3	9,10



Base 4 tomas T/T

Código	Mts.	P.V.
09304	1,5	6,30
09334	3	9,70



Base 5 tomas T/T

Código	Mts.	P.V.
09305	1,5	7,00
09335	3	10,30



Base 6 tomas T/T

Código	Mts.	P.V.
09306	1,5	7,40
09336	3	10,80



Base 4 tomas con T/T

Código	Mts.	P.V.
09142	1,5	7,40



Base 3 tomas T/T + Interrup.

Código	Mts.	P.V.
09613	1,5	6,80
09633	3	9,50
09653	5	15,10



Base 4 tomas T/T + Interrup.

Código	Mts.	P.V.
09614	1,5	7,70
09634	3	10,10
09654	5	15,80



Base 5 tomas T/T + Interrup.

Código	Mts.	P.V.
09615	1,5	8,40
09635	3	11,30
09655	5	16,40



Base 6 tomas T/T + Interrup.

Código	Mts.	P.V.
09616	1,5	8,60
09636	3	11,60
09656	5	17,10



Base 4 tomas T/T

Código	Mts.	P.V.
09686	3	8,70



Base 4 tomas T/T + Interrup

Código	Mts.	P.V.
09692	1,5	7,70



Base 6 tomas T/T + Interrup

Código	Mts.	P.V.
09694	1,5	8,70

# SERIE EXTRA

## BASES MÚLTIPLES

**MANGUERA**  
3G1,5 MM, Y HO5VV-F  
DE 1,5 MTS.



Base 3 tomas T/T 1,5 mts.

Código		P.V.
09373	10	6,20



Base 4 tomas T/T 1,5 mts.

Código		P.V.
09374	10	7,40



Base 6 tomas T/T 1,5 mts.

Código		P.V.
09376	10	8,20



Base 3 tomas T/T 1,5 mts.+ Int.

Código		P.V.
09383	10	7,60



Base 4 tomas T/T 1,5 mts.+Int.

Código		P.V.
09384	10	8,40



Base 6 tomas T/T 1,5 mts.+ Int.

Código		P.V.
09386	10	9,40

Nueva presentación

Retráctil  
con solapa







- Una base desplazada para mejor posicionamiento.
- Se puede fijar directamente a la pared.
- Con protectores niños.

#### Bases Múltiples con T/T

Código			P.V.
09412	2 tomas	24	7,70
09413	3 tomas	24	8,20
09414	4 tomas	24	9,40
09416	6 tomas	24	10,60

#### Bases Múltiples con T/T

Con 2 mts. manguera flexible de PVC H05VV-F 3X1,5 mm.

09422	2 tomas	12	12,80
09423	3 tomas	12	13,50
09424	4 tomas	12	14,40
09426	6 tomas	12	16,40

#### Bases Múltiples con T/T

Con 3 mts. manguera flexible de PVC H05VV-F 3X1,5 mm.

09433	3 tomas	12	15,40
09434	4 tomas	12	16,80
09436	6 tomas	12	18,40

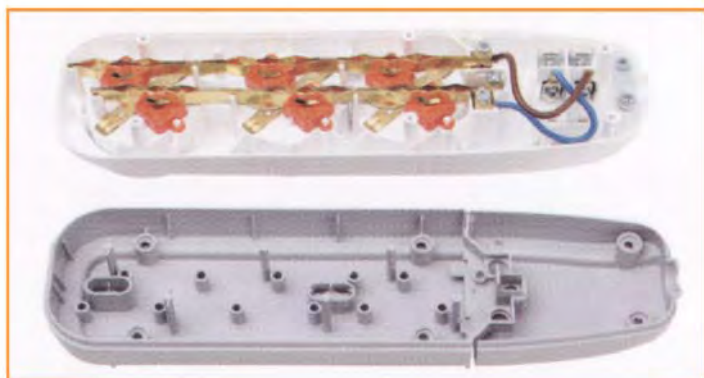



**2 ENTRADAS USB  
INCORPORADAS**

Base múltiple 5 tomas + 2 entradas USB 5V  
c/ interruptor Mang.H05RN-F 3X1,5mm.

Código	Mts.		P.V.
04003516	1,50	6	29,90



Base múltiple 1,5 mts. c/interruptor  
Mang.3X1,5mm.+ protector sobretensión

Código		P.V.	
005897	8 tomas	10	29,80



**Presentación  
caja a color**

Base con T/T + interruptor 3x1,5mm 1,5mts

Código		P.V.	
09265	8 tomas	10	31,40
09266	10 tomas	10	41,90



Base con T/T + interruptor individual 3x1,5mm 1,5mts

Código		P.V.	
09279	4 tomas	10	18,40
09280	6 tomas	10	23,90



Código	Color	Mod.			Código	Precio	Precio	
					Blíster	Granel	Blíster	
Clavija Cetta 16A								
11113	2P+T	azul	220V	10	111134	4,98	5,48	
11114	3P+T	roja	380V	10	111141	5,30	5,80	
11115	3P+T+N	roja	380V	10	111158	6,20	6,70	

#### Clavija Cetta 32A

11133	2P+T	azul	220V	10	111332	5,94	6,44
11134	3P+T	roja	380V	10	111349	6,80	7,30
11135	3P+T+N	roja	380V	10	111356	8,20	8,70

#### Base aérea Cetta 16A

11213	2P+T	azul	220V	10	112131	5,80	6,30
11214	3P+T	roja	380V	10	112148	6,90	7,40
11215	3P+T+N	roja	380V	10	112155	7,80	8,30

#### Base aérea Cetta 32A

11233	2P+T	azul	220V	10	112339	8,10	8,60
11234	3P+T	roja	380V	10	112346	8,70	9,20
11235	3P+T+N	roja	380V	10	112353	9,96	10,46

Los códigos de blíster 112155 y 112353 van en solapa

#### Base empotrar Cetta 16A

11610	Schuko	azul	220V	20		3,90	
11620	2P+T	azul	220V	10		5,20	
11621	3P+T	roja	380V	10		6,20	
11622	3P+T+N	roja	380V	10		6,90	

#### Base empotrar Cetta 32A

11625	2P+T	azul	220V	10		7,20	
11626	3P+T	roja	380V	10		7,90	
11627	3P+T+N	roja	380V	10		8,80	

#### Base superficie Cetta 16A

11631	2P+T	azul	220V	10		7,20	
11632	3P+T	roja	380V	5		8,10	
11633	3P+T+N	roja	380V	5		9,80	

#### Base superficie Cetta 32A

11635	2P+T	azul	220V	5		9,20	
11636	3P+T	roja	380V	5		9,70	
11637	3P+T+N	roja	380V	5		10,80	



Código	Color	Mod.	Voltaje		Precio
<b>Clavija Cetta 16A - IP67</b>					
11313	2P+T	azul	220V	10	7,45
11314	3P+T	roja	415V	10	8,80
11315	3P+T+N	roja	240-415V	10	10,30

<b>Clavija Cetta 32A - IP67</b>					
11323	2P+T	azul	220V	10	11,35
11324	3P+T	roja	415V	10	12,55
11325	3P+T+N	roja	240-415V	10	14,50

<b>Clavija Cetta 63A - IP67</b>					
11333	2P+T	azul	220V	1	35,00
11334	3P+T	roja	415V	1	40,00
11335	3P+T+N	roja	240-415V	1	45,00

### Clavijas y bases de IP67

<b>Base aérea Cetta 16A - IP67</b>					
11353	2P+T	azul	220V	10	9,00
11354	3P+T	roja	415V	10	10,40
11355	3P+T+N	roja	240-415V	10	12,00

<b>Base aérea Cetta 32A - IP67</b>					
11363	2P+T	azul	220V	10	13,70
11364	3P+T	roja	415V	10	14,90
11365	3P+T+N	roja	240-415V	10	17,10

<b>Base aérea Cetta 63A - IP67</b>					
11373	2P+T	azul	220V	1	40,00
11374	3P+T	roja	415V	1	44,00
11375	3P+T+N	roja	240-415V	1	48,00



Código	Mod.		Código Blíster	Precio €	Precio Blíster
Adaptador schucko a cetta 16A 230V					
11502	230V	12	115026	10,90	11,40

- Protección IP X4.
- Clavija también admite la base francesa.



Adaptador cetta a schucko 16A 230V					
11504	230V	12	115040	10,90	11,40

- Protección IP X4.



Adaptador cetta a schucko con tapa 16A 230V					
11503	230V	12	115033	19,80	20,30

- Protección IP X4.



Convertidor múltiple de cetta a schucko					
11510	230V	5	115101	17,80	18,30

- Toma corriente base cetta a base schucko.
- 2+T de 230V 16A salida cable lateral.
- Schucko de 16A a 230V.
- Protección IP X4.



10 mts. de cable  
3x2,5

Código		Precio tarifa	Precio oferta
1160496	1	52,50	24,50

- Triple cetac 16A 250V 2+T con 1,30 mts.
- Cable H07RN-F 3G2,5.
- Clavija Cetca 16A 2+T a
- 2 tomas Cetca 16A 2+T y
- 1 toma Schucko 230V 2+T.

1160497	1	58,8	26,50
---------	---	------	-------

- Triple cetac 16A 250V 2+T con 1,30 mts.
- Cable H07RN-F 3G2,5.
- Base cetca 16A 2+T a
- Base cetca 16A 2+T a
- Clavija cetca 16A 2+T a
- 2 toma schucko 230V 2+T.

11508	1	32,8	15,90
-------	---	------	-------

- Triple cetca 16A 250V 2+T.

11512	1	32,80	13,90
-------	---	-------	-------

- Torre cetac 16A 250V 2+T.
- Cable H05VV-F 3G2,5 azul con 10 mts.
- Clavija cetca 16A 2+T a
- 4 Base cetca 16A 2+T
- Conforme a la norma IEC309.
- IP44.

IP 44



# EXPOSITOR DE CANALETA

**CÓDIGO  
98071**



CÓDIGO	DESCRIPCIÓN	SECCIÓN	CANTIDAD METROS
--------	-------------	---------	-----------------

16002	CANALETA ADHESIVA	12X7	320
16004	CANALETA ADHESIVA	16X10	180
16006	CANALETA ADHESIVA	15X17	120
16008	CANALETA ADHESIVA	20X10	160
16010	CANALETA	12X7	180
16012	CANALETA	16X10	100
16014	CANALETA	15X17	60
16016	CANALETA	20X10	80
16018	CANALETA	25X17	50
16020	CANALETA	30X10	50
16022	CANALETA	40X17	30

# CANALETA Y ACCESORIOS

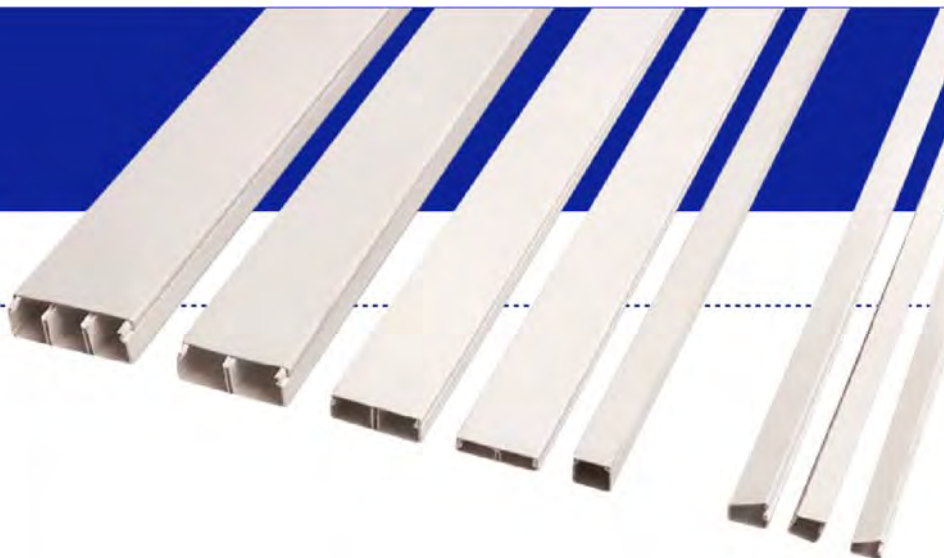

**ADHESIVA** 

 **ADHESIVA**

**ADHESIVA** 

 **ADHESIVA**

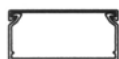

Descripción	CÓDIGO	Color	Unidad venta mtrs.	Precio tarifa
MINICANAL 12X7 AD	16002	Blanca	160	<b>1,10</b>
MINICANAL 16X10 AD	16004	Blanca	90	<b>1,40</b>
MINICANAL 15X17 AD	16006	Blanca	60	<b>1,90</b>
MINICANAL 20X10 AD	16008	Blanca	80	<b>1,65</b>
MINICANAL 12X7	16010	Blanca	180	<b>0,70</b>
MINICANAL 16X10	16012	Blanca	100	<b>0,95</b>
MINICANAL 15X17	16014	Blanca	60	<b>1,30</b>
MINICANAL 20X10	16016	Blanca	80	<b>1,12</b>
MINICANAL 25X17	16018	Blanca	50	<b>1,60</b>
MINICANAL 30X10	16020	Blanca	50	<b>1,50</b>
MINICANAL 40X17	16022	Blanca	30	<b>2,30</b>
MINICANAL 40X40	16024	Blanca	46	<b>3,10</b>
MINICANAL 60X40	16026	Blanca	32	<b>4,60</b>
MINICANAL 80X40	16028	Blanca	24	<b>6,30</b>
MINICANAL 100X40	16030	Blanca	16	<b>8,50</b>

**TODOS LOS PRECIOS SON POR MTS. ( TODAS LAS TIRAS TIENEN 2 MTS.)**



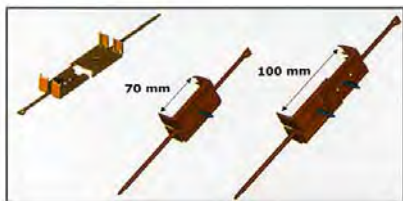
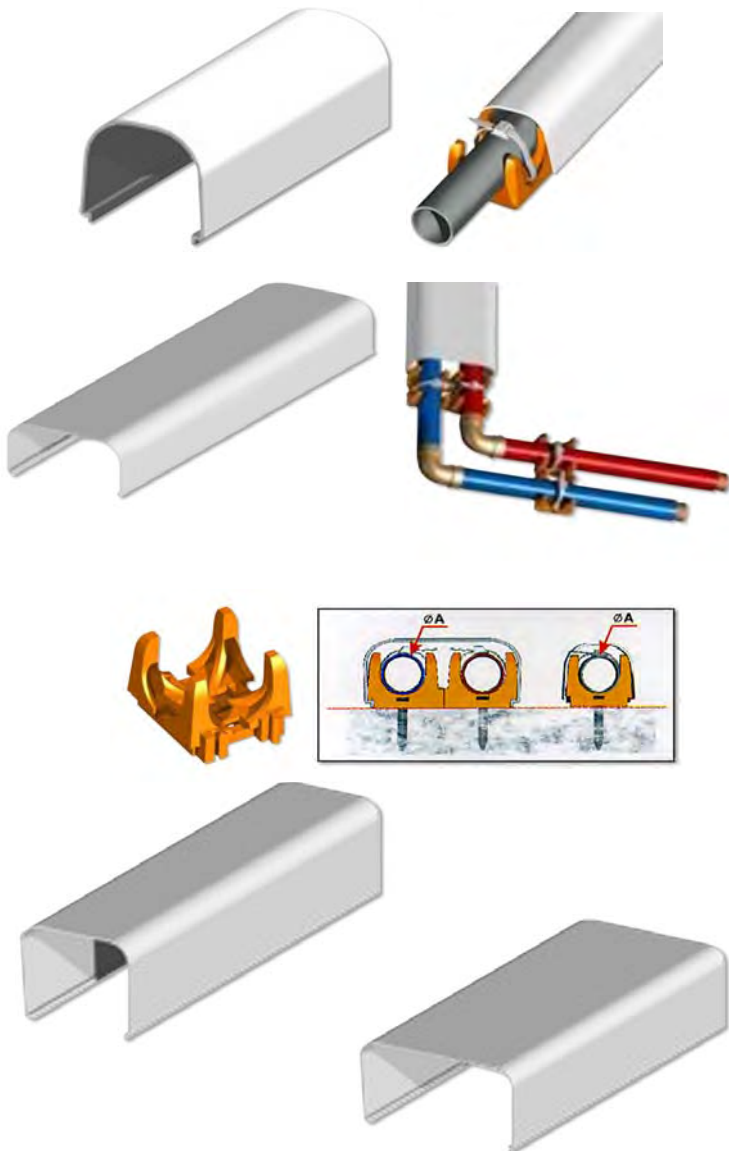

**OFERTA**  
**34€**

Código	Denominación	Mts.		Precio Granel
Canaleta gas			Tiras	X mt.
16201	T35X35	68	34	<b>2,80</b>

- Medida exterior: 35x35 mm.

Canaleta agua o calefacción				
16202	T70X40-TAPA	32	16	<b>3,90</b>
16208	T70X40-BASE	36	18	<b>3,90</b>



- Medida ext.: 77x34 mm.

Abrazadera tubos				
16210	35mm		50	<b>0,90</b>

- Incluidos tornillos + tacos.

Canaleta aire				
16203	T70X60-TAPA	24	12	<b>5,10</b>
16204	T100X60-TAPA	12	6	<b>6,10</b>
16205	T70X60-BASE	24	12	<b>5,10</b>
16206	T100X60-BASE	12	6	<b>6,10</b>

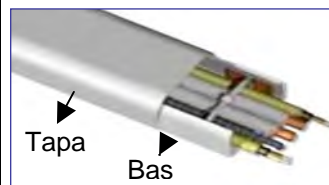

- Medida exterior:  
16203: 70x60 mm.

- Medida exterior:  
16204: 110x60 mm.

Abrazadera tubos aire				
16211	70 a 100mm.		25	<b>1,40</b>





Incluidos tornillos + tacos

Accesorios aire acondicionado				
16215	Union curva		50	<b>0,98</b>
16216	Derivación		50	<b>1,86</b>
16217	Unión recta		50	<b>0,42</b>

Manguera desagüe aire acondicionado Rollo				
93525	16X20	Blanca	50Mts.	<b>75,00</b>

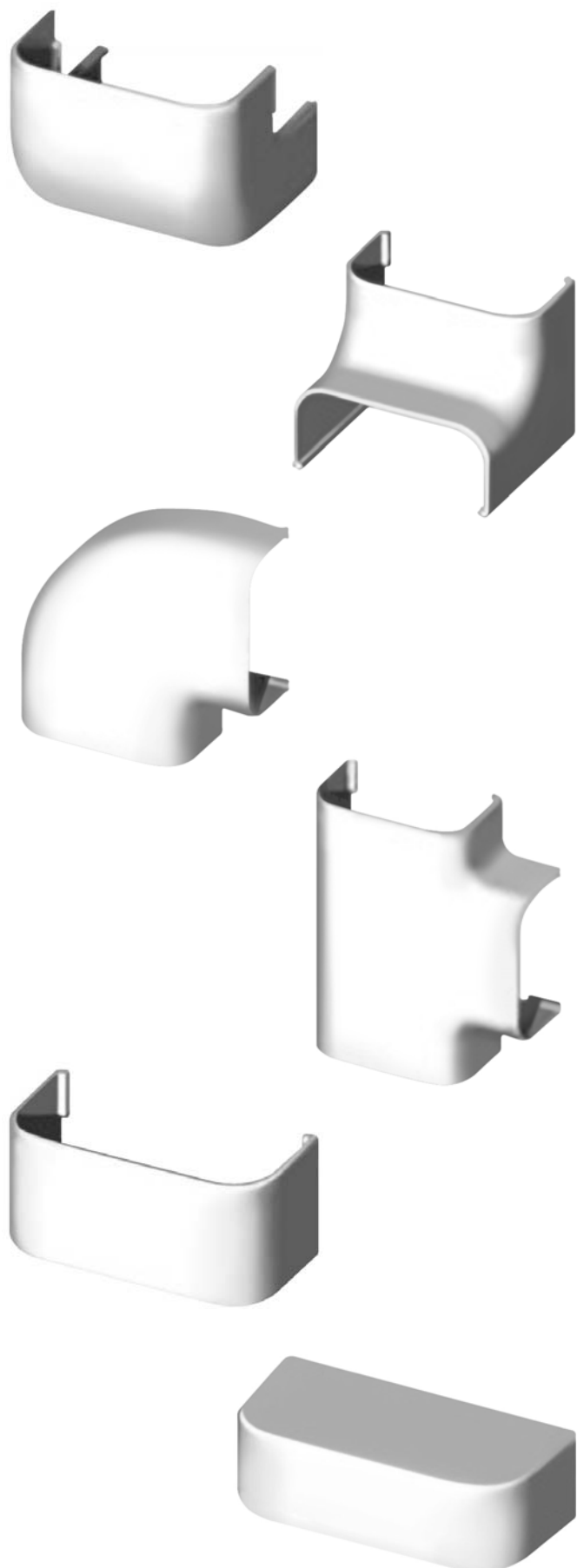
- Tubería fabricada pvc flexible espiral rígida casi indeformable.  
- Atóxico, pegado hermético.  
- Marca aenor norma une en iso 3994.



Código	Medidas		Precio Grael
<b>Ángulo exterior</b>			
16250	35X35	10	<b>2,30</b>
16251	70X40	10	<b>3,10</b>
16252	70X60	10	<b>3,30</b>
16253	100X60	10	<b>3,90</b>
<b>Ángulo interior</b>			
16254	35X35	10	<b>2,30</b>
16255	70X40	10	<b>3,10</b>
16256	70X60	10	<b>3,30</b>
16257	100X60	10	<b>3,90</b>
<b>Ángulo plano</b>			
16258	35X35	10	<b>2,30</b>
16259	70X40	10	<b>3,10</b>
16260	70X60	10	<b>3,30</b>
16261	100X60	10	<b>3,90</b>
<b>Derivación en T</b>			
16262	35X35	10	<b>2,30</b>
16263	70X40	10	<b>3,10</b>
16264	70X60	10	<b>3,30</b>
16265	100X60	10	<b>3,90</b>
<b>Unión</b>			
16266	35X35	10	<b>2,30</b>
16267	70X40	10	<b>3,10</b>
16268	70X60	10	<b>3,30</b>
16269	100X60	10	<b>3,90</b>
<b>Tapa final</b>			
16270	35X35	10	<b>2,30</b>
16271	70X40	10	<b>3,10</b>
16272	70X60	10	<b>3,30</b>
16273	100X60	10	<b>3,90</b>

PARA 280 + 45+25%  
PARA 560 + 45+30%



Caja empotrar universal 9 ent.  
enlazable

Código	Md.		P.V.
17129	75X75X40	10/280	<b>0,41</b>

PARA 100 + 45+15%

PARA 500 + 45+25%  
PARA 1000 + 45+30%



Caja empotrar universal 9 ent.  
para tubo de 25 aloj. Para 4 tor. AENOR

Código	Md.		P.V.
17128	65X65X40	20/500	<b>0,42</b>

PARA 100 + 45+15%

PARA 100 + 45+15%



Caja empo. redonda, tapa c/pest. plast.  
7 entradas para tubo de 16

Código	Md.		P.V.
17053	60X40	20	<b>0,98</b>

PARA 100 + 45+15%



Caja empotrar redonda, tapa c/garra  
metálica, 6 entradas para tubo de 25

Código	Md.		P.V.
17061	80X40	8	<b>1,48</b>



Caja empotrar garras metal

Código	Md.		P.V.
17103	100X100X45	5/50	<b>1,20</b>
17111	170X110X50	5/50	<b>2,20</b>



Caja empotrar con tornillos

Código	Md.		P.V.
17104	100X100X45	10	<b>1,40</b>
17105	200X200X65	<b>32</b>	<b>5,60</b>



Caja empotrar 14 entradas para tubo  
de 32 y 10 entradas para tubo de 40.  
Tapa c/tornillos y 2 tabiques separadores

Código	Md. Caja		P.V.
17116	300X160x70	<b>31</b>	<b>8,70</b>

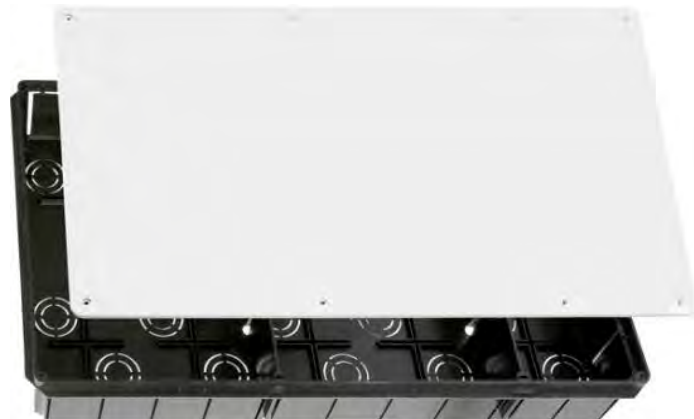

Caja empotrar 50 entradas para tubo de 40.  
Tapa c/tornillos y 2 tabiques separadores

Código	Md. Caja		P.V.
17118	300X500X60	<b>10</b>	<b>19,70</b>

PARA 100 + 45+15%

Pladur



Caja empotrar tabiques huecos  
4 entradas tubo 20mm. Enlaz.

Unión caja de empotrar 17205

Caja empotrar doble tabiques  
tabiques huecos ( pladur )

Código	Md.		P.V.
17205	68X46	20	1,45

Código	Md.		P.V.
17206	pladur	50	0,25

Código	Md.		P.V.
17225	136X68X42	10	2,70

PARA 120 + 45+15%

Pladur



Pladur



Caja de empalmes red.

Caja de empalmes red.

Código	Md.		P.V.
17214	100X46	4	4,60

Código	Md.		P.V.
17216	150X46	4	4,96

Código	Md.		P.V.

PARA 100 + 45+15%



Caja pladur 4 entradas  
para tubo de 20mm.  
Se suministra con la  
unión para enlazar.

Caja registro pladur  
4 entradas tubo de 20mm.  
6 entradas para tubo 25mm.

Código	Md.		P.V.
17235	65X50	10/300	1,10

PARA 80 + 45+15%

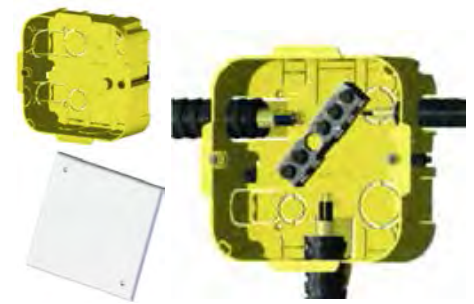

Código	Md.		P.V.
17238	110X40	8	2,30



Zocalo universal para 1 elem.

Zocalo universal para 2 elem.

Zocalo universal para 3 elem.

Código	Md.		P.V.
17091	94X96X43	96	3,40

Código	Md.		P.V.
17092	253X96X43	52	4,30

Código	Md.		P.V.
17093	165X96X43	38	5,60



IP 54

Caja estanca red. superficie

Código	Medida		P.V.
17186	80X45	8	1,60



IP 54

Caja estanca superficie  
cierre por presión

Código	Medida		P.V.
17152	80X80X50	10	2,40
17160	100X100X50	175	3,90



IP 65

Caja estanca superficie  
con tornillos 1/4 de vuelta

Código	Medida		P.V.
17194	100X100X55	90	3,60
17162	150X110X70	48	4,90



IP 65

Caja estanca superficie  
con tornillos 1/4 de vuelta

Código	Medida		P.V.
17165	175X110X66	36	8,20
17166	175X110X83	36	8,90



IP 65

Caja estanca superficie  
con tornillos 1/4 de vuelta

Código	Medida		P.V.
17170	190X150X70	27	9,90
17179	220X170X120	12	13,80
17180	315X215X125	10	54,00



IP 55

Caja estanca superficie  
paredes lisas

Código	Medida		P.V.
17182	315x215x25	10	49,00



Caja distribución de superficie  
de 1 a 2 elementos

Código	Medida		P.V.
17037	40X140X58	10	2,80



Caja distribución de superficie  
de 1 a 4 elementos

Código	Medida		P.V.
17034	82X172X61	10	3,90



Caja de superficie red. rosca  
con membranas en salidas

Código	Medida		P.V.
17400	65X40	20	1,96
17402	80X40	20	2,60
17403	100X50	10	3,40



**17140**
**17147 con tornillo 1/4 vuelta**

Caja estanca red. Superficie cierre por presión 4 conos

Código	Medida		P.V.
17140	80X40	10/200	<b>1,30</b>
17147	105X105X55	5/100	<b>3,30</b>



**17146**
**17141**

Caja estanca superficie cierre por presión 7 conos

Código	Medida		P.V.
17146	65X65X40	10/200	<b>1,50</b>
17141	80X80X40	10/200	<b>1,80</b>



Caja estanca superficie con tornillos inox. 6 conos

Código	Medida		P.V.
17143	120X80X50	5/100	<b>3,30</b>



Caja estanca superficie con tornillos inox. 6 conos

Código	Medida		P.V.
17142	100X100X50	5/100	<b>3,30</b>



Caja estanca superficie con tornillos inox. 10 conos

Código	Medida		P.V.
17144	150X110X70	3/72	<b>5,20</b>



Caja estanca superficie con tornillos inox. 10 conos

Código	Medida		P.V.
17145	190X140X70	3/36	<b>8,80</b>

Todas fabricadas en material polistireno antichoque, autoextinguible y todas retractiladas una a una con código de barras.  
Tornillos prisioneros ( no caen ) y en acero inoxidable.



Caja para ICP y distribución. Empotrar Serie Clásica.  
Color: Blanca sin puerta.

Código	Medida	Nº elem.		P.V.
17010	277X188X55	ICP 1-4 + 8	36	11,50
17020	348X188X55	ICP 1-4 + 12	24	13,20
17030	420X188X55	ICP 1-4 + 16	20	16,40



Caja distribución. Empotrar Serie Clásica.  
Color: Blanca sin puerta.

Código	Medida	Nº elem.		P.V.
17011	230X188X55	10	40	8,50
17012	277X188X55	14	36	10,90
17013	348X188X55	18	24	13,20



Caja para ICP y distribución. Empotrar Serie Clásica.  
Color: Blanca con puerta.

Código	Medida	Nº elem.		P.V.
17021	277X188X55	ICP 1-4 + 8	24	17,90
17022	348X188X55	ICP 1-4 + 12	18	20,80
17023	420X188X55	ICP 1-4 + 16	16	23,80



Caja distribución. Empotrar Serie Clásica.  
Color: Blanca con puerta.

Código	Medida	Nº elem.		P.V.
17014	230X188X55	10	28	15,20
17015	277X188X55	14	24	16,20
17016	348X188X55	18	18	19,60



Marcos y puertas Blancos para los siguientes  
Códigos: 17010 - 17020 - 17030

Código	Medida		P.V.
17041	Para 17011-17035	45	7,70
17042	Para 17010-17012-17036	36	9,50
17043	Para 17020-17013	30	9,90
17044	Para 17030	28	11,90



Caja para ICP y distribución. Superficie ICP de 1 a 4  
elementos y hasta 40A.  
Distribución hasta 6 y 8 elementos.

Código	Medida	Nº elem.		P.V.
17035	235X188X55	4+6	36	13,80
17036	277X188X55	4+8	30	15,60

# SERIE ARELOS



Caja para ICP 40A y distribución. Empotrar Serie Arelos. Color Blanca con puerta.

Código	Medida	Nº elem.		P.V.
17004	382X226X72	4 + 12	10	25,60



Caja para ICP 40A y distribución. Empotrar Serie Arelos. Color Blanca con puerta.

Código	Medida	Nº elem.		P.V.
17007	450X222X72	4 + 16	10	30,40



Caja para ICP 40A y distribución. Empotrar Serie Arelos. Color Blanca con puerta.

Código	Medida	Nº elem.		P.V.
17005	533X226X72	4 + 18	8	33,50



Caja para ICP 40A y distribución. Empotrar Serie Arelos. Color Blanca con puerta.

Código	Medida	Nº elem.		P.V.
17002	320X420X75	4 + 20	5	40,30



Caja distribución. Empotrar Serie Arelos  
Color: Blanca con puerta

Código	Medida	Nº elem.		P.V.
17000	277X220X72	14	10	17,90



Caja distribución. Empotrar Serie Arelos  
Color: Blanca con puerta

Código	Medida	Nº elem.		P.V.
17001	386X225X72	18	12	23,60





Caja para ICP ó distribución Empotrar 2 elementos y hasta 40A. Color Blanco.

Código	Medida		P.V.
17300	60X129X62	66	2,90



Caja para ICP ó distribución Superficie 2 elementos y hasta 40A. Color Blanco.

Código	Medida		P.V.
17301	62X140X85	60	3,30



Caja estanca IP54 IK 07 Precintable. Cierre con tornillos 1/4 vuelta 3 elem.

Código	Medida		P.V.
17195	75X145X75	50	17,90



Caja estanca IP54 IK 07 Precintable. Cierre con tornillos 1/4 vuelta 6 elem.

Código	Medida		P.V.
17197	135X160X70	50	23,40



Caja estanca IP54 IK 07 Precintable. Cierre con tornillos 1/4 vuelta 8 elem.

Código	Medida		P.V.
17196	160X135X70	50	22,60



ICP de 1 a 4 elementos y hasta 40A, distribución hasta 20 elementos.

Código	Medida		P.V.
17199	220X170X80	28	41,60



- Caja para distribución superficie 3 elementos.
- Serie INDUBOX IP65, IK 08.
- Precintable cierre de puerta con maneta de plástico.

Código	Medida		P.V.
17303	85X155X100	50	18,60



- Caja para distribución superficie 4 elementos.
- Serie INDUBOX IP65, IK 08.
- Precintable cierre de puerta con maneta de plástico.

Código	Medida		P.V.
17304	120X200X115	33	22,20



- Caja para distribución superficie 6 elementos.
- Serie INDUBOX IP65, IK 08.
- Precintable cierre de puerta con maneta de plástico.

Código	Medida		P.V.
17306	170X200X115	24	24,90



- Caja para distribución superficie 8 elementos.
- Serie INDUBOX IP65, IK 08.
- Precintable cierre de puerta con maneta de plástico.

Código	Medida		P.V.
17308	215X200X115	19	29,90

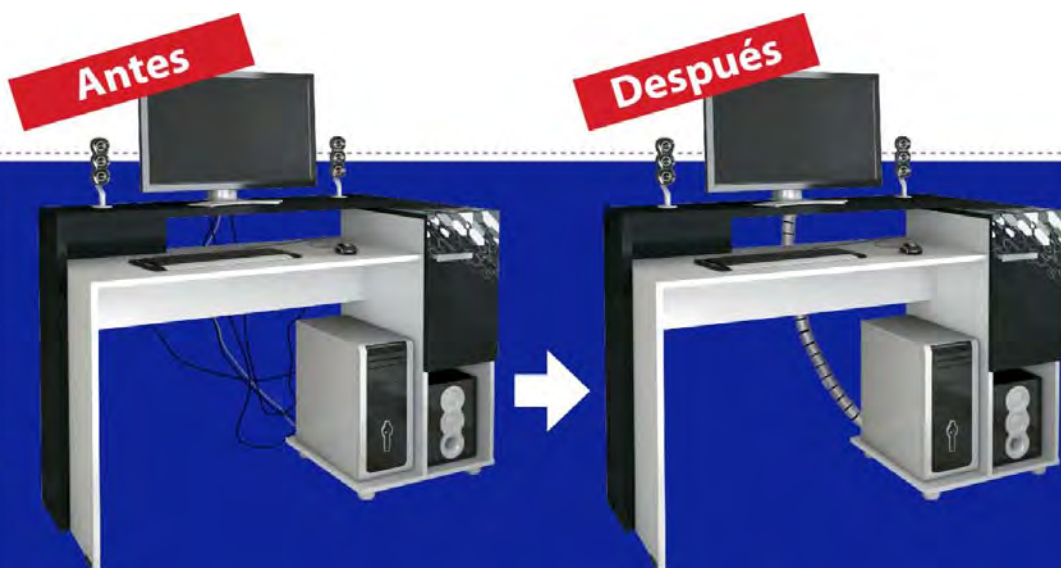

## Guías organizadoras de cables



Descripción	Código	Color	Mtrs.		Precio
TUBO + CLIP 20mm.	16720	Gris	2,5	10	8,20
TUBO + CLIP 25mm.	16725	Gris	2,5	10	9,40

- Tubo organizador cables de 2,5 metros.
- Se pueden unir sin tope de distancia y cortar.
- Llevan una pinza clip para introducir los cables sin ningún tipo de esfuerzo, ideal para recoger detrás de ordenadores o donde estén situados aparatos múltiples.
- Hay tres tipos de ancho 15, 20, 25 mm.
- Presentación en bolsa con solapa.



# TERMINALES

# EXPOSITOR TERMINALES

**CÓDIGO:  
98050**



CÓD.	DESCRIPCIÓN	CANT.	PVP
------	-------------	-------	-----

19051	Faston H	100	0,10
19052	Faston H	100	0,10
19053	Faston H	50	0,18
19054	Faston M.	100	0,10
19055	Faston M.	100	0,10
19183	Faston M.	50	0,16
19023	Aro	100	0,10
19024	Aro	100	0,10
19025	Aro	50	0,15
19037	Aro	100	0,10
19038	Aro	100	0,10
19039	Aro	100	0,10
19040	Aro	100	0,10

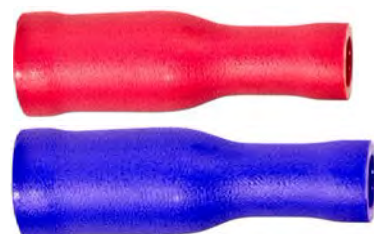

CÓD.	DESCRIPCIÓN	CANT.	PVP
------	-------------	-------	-----

19028	Horquilla	100	0,10
19029	Horquilla	50	0,15
19044	Horquilla	100	0,10
19045	Horquilla	100	0,10
19046	Horquilla	100	0,10
19050	Horquilla	25	0,15
19436	Manguitos H-H	100	0,10
19437	Manguitos H-H	50	0,10
19438	Manguitos H-H	25	0,14
19575	Faston AIS. H	50	0,18
19576	Faston AIS. H	50	0,18
19577	Faston AIS. H	25	0,18
19572	Faston M-H	50	0,18
19573	Faston M-H	50	0,18
19566	Conector M.	100	0,13
19567	Conector M.	100	0,13
19569	Conector H.	50	0,15
19570	Conector H.	50	0,15





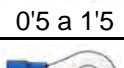

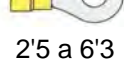

Código	Color	Sección		Piezas x blíster	Código	Precio Granel	Precio Blíster
Granel					Blíster		



**Terminales preaislados redondos**

19023		3'7	100	10	190238	0,10	1,20	
19037		4'3	100	10	190375	0,10	1,20	
19038	0'5 a 1'5	5'3	100	10	190382	0,10	1,20	
19024		3'7	100	10	190245	0,10	1,20	
19039		4'3	100	10	190399	0,10	1,20	
19040	1'5 a 2'5	5'3	100	10	190405	0,10	1,20	
19025		2'5 a 6'3	6'4	100	5	190252	0,15	1,20

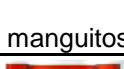

**Terminales preaislados horquilla**

19043		3'5	100	10	190436	0,10	1,20
19044		4'3	100	10	190443	0,10	1,20
19045		5'3	100	10	190450	0,10	1,20
19028		3'7	100	10	190283	0,10	1,20
19046		4'3	100	10	190467	0,10	1,20
19047		5'3	100	10	190474	0,10	1,20
19029		5'3	100	5	190290	0,15	1,20
19050		6'4	100	5	190504	0,15	1,20



**Terminales manguitos preaislados**

19436		1'5	100	5	194366	0,10	1,20
19437		2'5	100	5	194373	0,10	1,20
19438		4/6	100	5	194380	0,14	1,20

**Terminales cilíndricos macho preaislados**

19566		1'5	100	5	195660	0,13	1,20
19567		2'5	100	5	195677	0,13	1,20

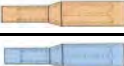

**Terminales cilíndricos macho preaislados**

19569		1'5	100	5	195691	0,15	1,20
19570		2'5	100	5	195707	0,15	1,20

Blíster unidad de venta 20 por caja



Código Granel	Color	Sección		Piezas x blíster	Código	Precio	Precio
					Blíster	Granel	Blíster

**Terminales faston hembra preaislados**

19051		1'5/6'3	100	10	190511	0,10	1,20
19052		2'5/6'3	100	10	190528	0,10	1,20
19053		6/6'3	100	5	190535	0,18	1,20

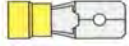

**Blíster unidad de venta 20 por caja**

**Terminales faston macho preaislados**

19054		1'5/6'3	100	10	190542	0,10	1,20
19055		2'5/6'3	100	10	190559	0,10	1,20
19183		6/6'3	100	5	191839	0,16	1,20

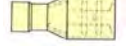

**Blíster unidad de venta 20 por caja**

**Terminales faston hembra aislados**

19575		1'5/6'3	100	5	195752	0,18	1,20
19576		2'5/6'3	100	5	195769	0,18	1,20
19577		6/6'3	100	5	195776	0,18	1,20

**Blíster unidad de venta 20 por caja**

**Terminales faston macho/hembra preaislados**

19572		1'5/6'3	100	5	195721	0,18	1,20
19573		2'5/6'3	100	5	195738	0,18	1,20
19574		2'5/6'4	100	5	195745	0,22	1,20

**Blíster unidad de venta 20 por caja**

**Punteras preaisladas**

19090	Blanca	0,5mm	100			0,04	
19091	Azul	0,75mm	100			0,04	
19092	Roja	1mm	100			0,04	
19093	Negra	1,5mm	100			0,06	
19094	Gris	2,5mm	100			0,06	
19095	Naranja	4mm	100			0,08	
19096	Verde	6mm	100			0,10	
19097	Marfil	10mm	100			0,12	
19098	Marfil	16mm	100			0,16	



Código	Color	Metros		Precio Solapa
--------	-------	--------	---	---------------

Fabricadas en poliamida 6. macizas cabezal flexible guía curvas y de enganche **fijas**.

19445	Blanca	5	6	<b>3,90</b>
19446	Blanca	10	6	<b>6,20</b>
19447	Blanca	15	6	<b>8,30</b>
19448	Blanca	20	6	<b>9,70</b>
19449	Blanca	25	6	<b>11,40</b>
19450	Blanca	30	6	<b>12,90</b>

Fabricadas en poliamida 6. macizas cabezal flexible guía curvas y de enganche **desenroscable de latón**.

19452	Blanca	5	6	<b>4,38</b>
19454	Blanca	10	6	<b>6,84</b>
19456	Blanca	15	6	<b>8,93</b>
19458	Blanca	20	6	<b>10,66</b>
19459	Blanca	25	6	<b>12,50</b>

De acero recubierto en nylon de 3,8 mm.

Guía curvas de enganche **desenroscable de latón**.

19470	Rojo	10	1	<b>15,40</b>
19471	Rojo	15	1	<b>21,00</b>
19472	Rojo	20	1	<b>29,90</b>
19473	Rojo	30	1	<b>40,80</b>
19474	Rojo	50	1	<b>67,00</b>

Pasahilos con doble fuerza motriz, fabricados con cable helicoidal de acero recubierto en nylon de 3,8 mm. Terminales en **acero inoxidable fijos**

19461	Rojo	10	1	<b>15,40</b>
19462	Rojo	15	1	<b>21,00</b>
19463	Rojo	20	1	<b>29,90</b>
19464	Rojo	30	1	<b>40,80</b>
19465	Rojo	50	1	<b>67,00</b>

<b>19589</b>	estándar	juego	4	<b>2,91</b>
--------------	----------	-------	---	-------------

En dos operaciones, pasar, atar y tirar.

Puntas de recambio para series de poliamida y polipropileno.

**Blister**

Alicates para terminales preaislados

<b>19885</b>	de 0,5mm a 6mm.	6	<b>17,90</b>
--------------	-----------------	---	--------------

Alicates para terminales NO aislados

<b>19990</b>	de 1mm a 10mm.	6	<b>17,90</b>
--------------	----------------	---	--------------

Alicates para punteras

<b>19995</b>	de 0,5mm a 4mm.	6	<b>19,80</b>
<b>19996</b>	de 6mm a 16mm.	6	<b>19,80</b>





LED  
LED

LINTERNAS  
LED





### Linterna 9 LED blanco

Código		P.V.
20190	16 / 32	4,70

Cuerpo de aluminio 10 cm.  
Utiliza 3 baterías LR03 (no incluidas).



### Linterna 9 LED blanco

Código		P.V.
20193	16	3,40

Cuerpo de aluminio 9 cm.  
Utiliza 3 baterías LR03 (no incluidas).



### Linterna 21 LED blancos

Código		P.V.
20145	12/72	7,90

Cuerpo de aluminio 10 cm.  
Utiliza 3 baterías LR03 (no incluidas).

*¡Illuminate con la mejor calidad!*



oferta  
2,99€

**1W**



Código		P.V.
Linterna súper led 1W blanco		
20191	16	<b>6,95</b>

- Cuerpo de aluminio 10cm.
- Utiliza 3 baterías LR03 (no incluidas).



oferta  
6,80€



**3W**

Linterna súper led 3W blanco		
20140	6	<b>14,60</b>

- Cuerpo de aluminio 10cm.
- Utiliza 3 baterías LR03 (no incluidas).

*¡Illuminate con la mejor calidad!*

**LOS PRECIOS OFERTA SOLO SE APLICAN PARA CAJAS COMPLETAS**

oferta  
5,40€

oferta  
4,95€



oferta  
2,90€



oferta  
19,90€

Código		P.V.
Linterna 1 led de 3W <b>con zoom</b>		
20072	6	11,50



- Con interruptor ON/OFF.
- Cabeza orientable verticalmente.
- Tres posiciones de luz; 50% 100% e inter.
- Batería 3 R03 (no incluidas).

# 3W

Linterna frontal 21 led		
20069	6	10,80



- Con interruptor ON/OFF.
- Se pueden encender 7 o 21 inter.
- Batería 3 R03 (no incluidas).

Linterna frontal 9 led		
04002626	10	7,20



- Con interruptor ON/OFF.
- Cabeza orientable verticalmente.
- Batería 3 R03 (incluidas).

Linterna frontal 5W SMD led		
20075	6	25,40

- Linterna **SMD 5W** RECARGABLE
- Luz blanca brillante.
- Funciona con 2 baterías MOD.18650 recargables 1200mAh (no incluidas).

# 5W

Cuerpo de aluminio y de plástico.  
300 Lúmenes.  
Resistente a salpicaduras.  
Autonomía: 3,5 hr. aprox. 100% Potencia.  
10,5 hr. aprox. 50% Potencia.

Incluye cargador (110-250V AC)  
Alcance de iluminación: 200 mts aprox.  
Inclinación vertical ajustable.  
El cabezal puede rotar hasta 90°.  
Correa ajustable para la cabeza.



**3W**



**3W**



**3W**

Código		P.V.
Linterna frontal Led 1 COB 3W		
HL343L	10	15,90

- 220-240V / 50-60Hz.
- Utiliza batería recargable 4V 900mAh.
- 3W 200 lumen.
- Distancia de alcance 30 mts.
- Autonomía de 1 a 4 horas.
- tiempo de carga 12-15 horas.

**recargable**

Linterna frontal Led 9 led SMD.		
HL349L	10	12,40

- 220-240V / 50-60Hz.
- Utiliza batería recargable 4V 900mAh.
- 0,9W 45 lumen.
- Distancia de alcance 20 mts.
- Autonomía de 4 a 16 horas.
- tiempo de carga 12-15 horas.

**recargable**

Linterna frontal 3W COB led		
20073	12	12,90

- Ahorro de energía 4 funciones
- Inclinación vertical
- Utiliza 3 baterías LR03 (no incluidas).





oferta  
2,99€

Linterna frontal 5 Leds blancos

Código		P.V.
20074	12	8,20

- \* Extensible y multifunción con iman .
- \* 3 funciones, ON/off-luz fija e intermitente.



oferta  
2,99€

Set iluminación para bicicleta led

Código		P.V.
27141	12	9,20



Mini Flexo de lectura led c/pinza

Código		P.V.
04002639	12	2,90

- \* 3 leds.
- \* Incluye 3 baterias boton AG13.
- \* Medidas:6X2X5,8cm.



oferta  
1,35€





**Funciones:**

- ✓ 100% Potencia
- ✓ 50% Potencia
- ✓ Luz intermitente



**Funciones:**

- ✓ 100% Potencia
- ✓ 50% Potencia
- ✓ Luz intermitente



**Funciones:**

- ✓ 100% Potencia
- ✓ 50% Potencia
- ✓ Luz intermitente

Linterna aluminio LED recargable 3W

**Código**



**P.V.**

20141

12

**21,80**

- Linterna aluminio LED recargable 3W.
- Utiliza una batería mod.18650 1200mAh (INCL.)
- Autonomia: 2h.maxima potencia.  
5h. Potencia media.
- Flujo lumínico: 210 lumenes.
- Incluye cargador 220V.

**FUNCIÓN ZOOM**

**INCLUYE ADAPTADOR PARA SER UTILIZADO CON 3 BATERIAS R03**

**9,90€**

Linterna aluminio LED recargable 6W

**Código**



**P.V.**

20143

6

**39,00**

- Linterna aluminio LED recargable 6W.
- Utiliza dos baterías mod.18650 1200mAh (INCL.)
- Autonomia: 4h.maxima potencia.  
11h. Potencia media.
- Flujo lumínico: 350 lumenes.
- Alcance de iluminación: 200mt. aprox.
- Incluye cargador 220V.

**FUNCIÓN ZOOM**

**16,90€**

Linterna aluminio LED recargable 10W

**Código**



**P.V.**

20144

6

**43,90**

- Linterna aluminio LED recargable **10W.**
- Utiliza una batería mod.26650 3000mAh (INCL.)
- Autonomia: 2h.maxima potencia.  
4h. Potencia media.
- Flujo lumínico: 1000 lumenes.
- Incluye cargador 220V.

**FUNCIÓN ZOOM**

**INCLUYE ADAPTADOR PARA SER UTILIZADO CON 3 BATERIAS R03**

**1000 lumenes 19,90€**

# LINTERNA RECARGABLE

## DUAL LED 3W

**COB  
LED**



Linterna recargable dual led 3W

**Código**

20101



6

**P.V.**

43,50

### Características

Material	ABS
Potencia	3W COB LED
Autonomía	4 hrs
Medidas	27x7 cm
Baterías	MOD 18650 1800mAh

- ✓ Con indicador de carga.
- ✓ Con gancho para colgar.
- ✓ Con imán que puede adherirse a cualquier superficie de metal.
- ✓ Especial para talleres.
- ✓ Accesorios incluidos:

- Adaptador AC.
- Adaptador 12V DC.
- Cargador Base.



**OFERTA**

**19.90€**



## LINTERNA EXPLORER



- Linterna "EXPLORER" recargable IP44.
- Lámpara halógena Philips 5,5V-1A.
- Luminosidad + 300%.
- Cuerpo antichoque, e impermeable.
- Reflector de alta intensidad. Diam. 105mm.
- Batería de Pb hermética 6V- 4Ah extraíble.
- Interruptor impermeable.

### INCLUYE:

- ♦ Adaptador 12V coche.
- ♦ Cargador a 220V.
- ♦ Correo transporte.



COD: 20371

Presentación  
caja a color.

Linterna foco recargable EXPLORER

Código		P.V.
20371	4	49,60

- Cuerpo de ABS 2000 Lumens.
- Utiliza 1 lampara halogena 5,5V 1A
- Duración 4 horas.

**recargable**

## PRECIO OFERTA

Para 4 unidades: 20,90€

Para 8 unidades: 19,90€

Para 12 unidad. 17,90€

Repuestos

Código			P.V.
38045	Batería	6	12,80
20205	Lámpara	12	4,20
2037A	Cargador 220V		9,60
2037D	Portalámparas		2,30
2037E	Cuerpo goma		6,60



# 10W



Linterna Multifunción recargable LED CREE 10W

Código		P.V.
20372	5	78,90

- Cuerpo de PVC 600 Lumens.
- Utiliza 1 baterías 4000 mAh recargable.
- Foco y luz lateral ( full / 50% ) luz emergencia
- Medidas: 250X125X175.
- Cargador incluido.

**recargable**

**CARGADOR DE MOVILES Y TABLETS  
VIA USB**

## PRECIO OFERTA

Para 5 unidades: 36,90€

Para 10 unidades: 35,90€



**3W**

oferta  
19,90€

Linterna foco recargable 3W

Código		P.V.
20236	16	39,70

- Cuerpo de PVC 200 Lumens.
- Utiliza 1 baterías 4V 3Ah recargable.
- Duración 4 horas.
- Medidas: 210X118.
- Cargador incluido.

**recargable**



**3W**

oferta  
22,90€

Linterna foco recargable 3W

Código		P.V.
20237	16	46,50

- Cuerpo de PVC 200 Lumens.
- Utiliza 1 baterías 6V 4,5Ah recargable.
- Duración 6 horas.
- Medidas: 210X118.
- Cargador incluido.

**recargable**



**1,9W**

oferta  
13,50€

Linterna foco recargable 7 ó 19 leds 1,9W

Código		P.V.
20238	18	28,70

- Cuerpo de PVC 95 Lumens.
- Utiliza 1 baterías 4V 3Ah recargable.
- Duración 7 leds 24 horas.  
24 leds 10 horas.
- Medidas: 170X200.
- Cargador incluido.

**recargable**



**3,6W**

oferta  
19,50€

Linterna foco recargable 16 ó 36 leds 3,6W

Código		P.V.
20239	12	42,90

- Cuerpo de PVC 180 Lumens.
- Utiliza 1 baterías 4V 3Ah recargable.
- Duración 16 leds 15 horas.  
36 leds 6 horas.
- Medidas: 120X165.
- Cargador incluido.

**recargable**



**oferta  
7,95€**

Código		P.V.
Linterna camping COB 3W		
20058	12	19,50

- Linterna con asa para transporte ó colgar
- Proporciona luz de 360º
- Utiliza 3 baterías LR06 (NO INCLUIDAS).



**PLEGABLE**

Luz portatil COB LED 6W		
20095	12	15,90

- Utiliza 4 baterías LR06 (NO INCLUIDAS).
- Con 3 imanes



**oferta  
6,95€**



Luz portatil con sensor led		
20081	12	12,90

- Medidas: 160X50mm.
- Utiliza 3 baterías LR06 (NO INCLUIDAS).



**oferta  
5,90€**



**oferta**  
**2,95€**

**Código**



**P.V.**

Linterna 37 led con imán

20090

12

**9,60**

- Linterna con pinza e imán
- Cuerpo de ABS
- Utiliza 3 baterías LR06 (NO INCLUIDAS).



**oferta**  
**3,95€**

Linterna doble

20092

12

**9,90**

- Led COB 3w + linterna 1W
- Utiliza 3 baterías LR03 (NO INCLUIDAS).



**IMÁN**



**oferta**  
**4,90€**

Linterna iman extensible 3 leds

20094

12

**12,90**

- Cuerpo de Chapa pintado.
- Medidas: 170X23 Abierta 575X23mm.
- Utiliza 4 batería AG13 (NO INCLUIDAS).



**CABEZA MAGNÉTICA**



**oferta**  
**5,60€**



**Código**



**P.V.**

Linterna dual independiente con imán		
20091	12	<b>13,60</b>

- Linterna con pinza e imán
- Cuerpo de ABS
- Utiliza 3 baterías LR06 (NO INCLUIDAS).

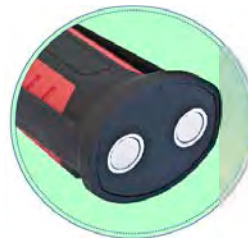

**IMANES**



**oferta**  
**4,50€**

Linterna Plegable led COB 3W

20098	12	<b>12,90</b>
-------	----	--------------

- Led COB 3W + linterna 1W
- Utiliza 3 baterías LR06 (NO INCLUIDAS).





Código		P.V.	Precio neto
Linterna 4 Led recargable			
HL331L	10	8,40	3,90

- Linterna 4 LED recargable.
- Con enchufe incorporado.
- Autonomía: 5 horas.
- Batería: 4V 400 mAh.



Linterna 5 Led recargable			
HL332L	10	9,80	4,60

- Linterna 5 LED recargable.
- Con enchufe incorporado.
- Autonomía: 4 horas.
- Batería: 4V 400 mAh.



Linterna 9 Led recargable			
HL333L	6	14,80	6,90

- Linterna 9 LED recargable.
- Con enchufe incorporado.
- Autonomía: 5 horas.
- Batería: 4V 1000 mAh.





**oferta**  
**6,90€**



Código		P.V.
Linterna bolígrafo		
04002971	6	14,30

- Linterna 9 SMD led. 180 Lúmenes
- Cuerpo de Aluminio. y clip magnético
- Utiliza 3 baterías LR06 (INCLUIDAS).



**oferta**  
**3,99€**

Linterna petaca 3 led

2027129	12	9,80
---------	----	------

- Cuerpo de Aluminio.
- Utiliza 3 baterías LR03 (INCLUIDAS).



**oferta**  
**1,49€**

Linterna llavero 4 led c/ mosqueton

2056372	24	3,25
---------	----	------





**oferta**  
**1,20€**



**oferta**  
**1,20€**



**oferta**  
**0,99€**



**oferta**  
**0,99€**



**1W**



**oferta**  
**1,95€**

Código		Precio tarifa
<b>Linterna llavero</b>		
2027162	24	<b>2,70</b>
<ul style="list-style-type: none"> <li>- Linterna llavero led con cuerpo de aluminio.</li> <li>- Utiliza 3 baterías AG13 (INCLUIDAS).</li> </ul>		
<b>Linterna llavero con lupa</b>		
2027163	24	<b>2,70</b>
<ul style="list-style-type: none"> <li>- Linterna llavero led con cuerpo de aluminio.</li> <li>- Utiliza 3 baterías AG13 (INCLUIDAS).</li> </ul>		
<b>Llavero bombilla led</b>		
2046655	75 pzas.	<b>2,20</b>
<ul style="list-style-type: none"> <li>- Cuerpo de plástico.</li> <li>- Baterías incluidas.</li> </ul>		
<b>Llavero linterna led</b>		
20096	40 pzas.	<b>2,20</b>
<ul style="list-style-type: none"> <li>- Linterna llavero 3 LED c/mosquetón.</li> <li>- Cuerpo de aluminio.</li> <li>- Utiliza 3 bat. AG13 (incluidas).</li> <li>- Medidas: 52mm.</li> <li>- Colores surtidos.</li> </ul>		
<b>Llavero linterna led C/IMAN</b>		
20099	24	<b>4,20</b>
<ul style="list-style-type: none"> <li>- Linterna llavero LED c/mosqueton <b>1W</b></li> <li>- Cuerpo de goma</li> <li>- Utiliza 3 bat. AG13 (incluidas).</li> <li>- Medidas: 68x33mm</li> <li>- Colores surtidos</li> </ul>		



## FAROL LED



## FAROL DE ACEITE



Código	Color		P.V.
Farol 15 LEDS Regulable			
04002955	PLATA	12	14,90
04002957	VERDE	12	14,90
04002958	ROJO	12	14,90

- \* Incluye 4 baterías R06.
- \* Medidas; 27x15x11,5cm.

### Farol de aceite

20552	Cobre	12	11,90
-------	-------	----	-------

- Regulable.

### Farol de aceite

20551	Rojo	12	10,60
20553	Azul	12	10,60

- Regulable.



**blíster 2 pzs.**

Código	Modelo		P.V.
Lámpara estándar bayoneta			
20214	3'6V	50	<b>0,24</b>
<b>202146</b>	3'6V	12	<b>0,90</b>
20215	4'8V	50	<b>0,24</b>
<b>202153</b>	4'8V	12	<b>0,90</b>
20216	7'2V	50	<b>0,24</b>
<b>202160</b>	7'2V	12	<b>0,90</b>



**blíster 2 pzs.**

Código	Modelo		P.V.
Lámpara estándar esférica E10			
20241	2'5V	50	<b>0,24</b>
<b>202412</b>	2'5V	12	<b>0,90</b>
20243	3'7V	50	<b>0,24</b>
<b>202436</b>	3'7V	12	<b>0,90</b>
20242	4'8V	50	<b>0,24</b>
<b>202429</b>	4'8V	12	<b>0,90</b>



**blíster 2 pzs.**

Código	Modelo		P.V.
Lámpara gota lente E10			
20272	2'3V	50	<b>0,24</b>
<b>202726</b>	2'3V	12	<b>0,90</b>



Código	Modelo		P.V.
Motorcito 12V			
20481	4,5V	25	<b>1,40</b>

# COMPOSICIÓN KIT ESCOLAR

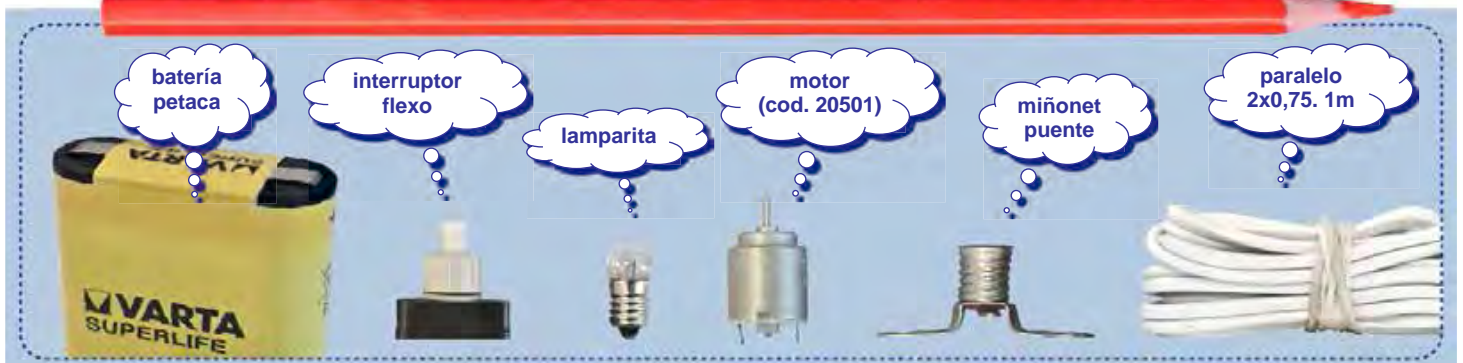

**KIT Cole**



Presentación en blister

**KIT Cole con motorcito**



Presentación en blister

Código	Modelo		P.V.
Kit Cole con interruptor			
20500	Interruptor	12	<b>4,90</b>

Código	Modelo		P.V.
Kit Cole con motor			
20501	Motor	12	<b>5,90</b>

# CINTA AISLANTE

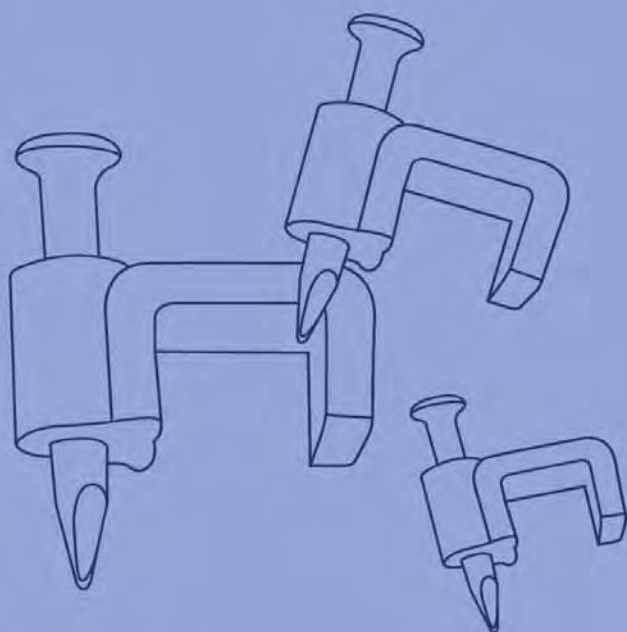
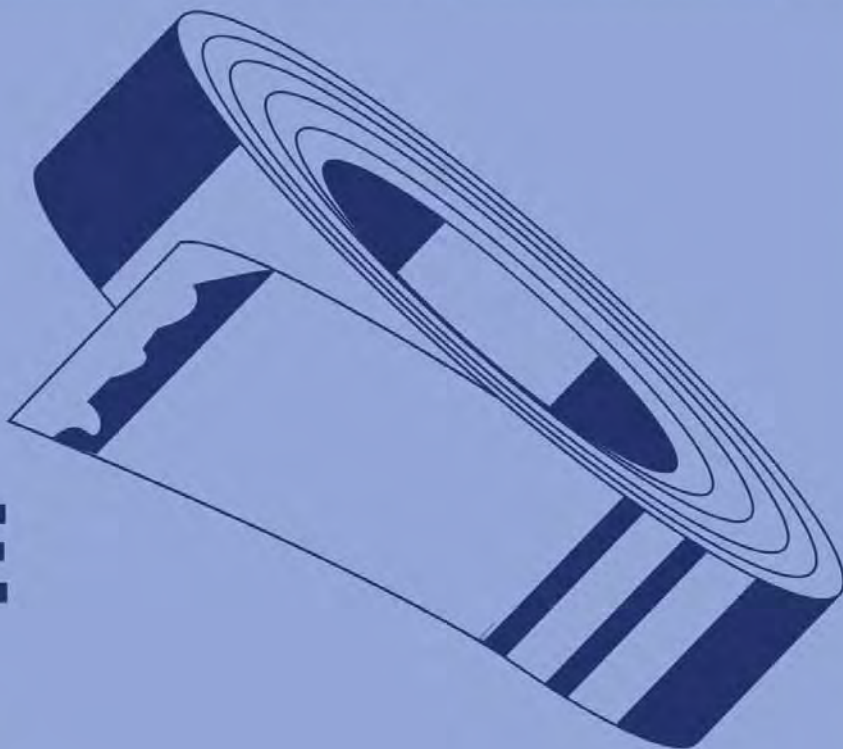

# GRAPAS

# BRIDAS



# CINTA AISLANTE



21089	Blanca	10	0,65
21097	Negra	10	0,65
21098	Gris	10	0,65
21103	Roja	10	0,65
21105	Azul	10	0,65
21139	Tierra	10	0,80

21147	Blanca	10	1,20
21170	Negra	10	1,20
21173	Gris	10	1,20
21175	Roja	10	1,20
21178	Azul	10	1,20
21568	Tierra	10	1,40

## Cinta aislante en blíster 10X19

## Cinta aislante en blíster 20X19

Código	Color		P.V.
210899	Blanca	20	1,05
210974	Negra	20	1,05
210981	Gris	20	1,05
211032	Roja	20	1,05
211056	Azul	20	1,05
211391	Tierra	20	1,20

Código	Color		P.V.
211476	Blanca	20	1,60
211704	Negra	20	1,60
211735	Gris	20	1,60
211759	Roja	20	1,60
211780	Azul	20	1,60
215689	Tierra	20	1,80

19mm x 5mts.  
Grosor 0,8mm.





Cinta aislante vulcanizada

# ANCHOS ESPECIALES



Cinta aislante 20X25



Código	Color		P.V.
21180	Negra	8	1,60
211803	Negra	16	2,00

Código	Color	Medidas	Uso			Código	Precio	Precio
						Blíster	Granel	Blíster
<b>Grapa para paralelo</b>								
22293	Blanca	01	telef/0'5	10=1000	20	222939	2,50	0,90
22296	Blanca	02	2x0'75	10=1000	20	222960	2,50	0,90
22368	Blanca	03	2x1	10=1000	20	223684	2,50	0,90
22301	Blanca	1	2x1'5	10=1000	15	223011	2,50	0,90

<b>Grapa para manguera</b>								
22319	Blanca	5	2x0'75	10=1000	15	223196	3,00	0,90
22327	Blanca	6	2x1	10=1000	15	223271	3,00	0,90
22335	Blanca	7	3x1	10=1000	15	223356	3,20	0,90
22343	Blanca	8	3x1'5	10=1000	15	223431	3,60	0,90
22426	Blanca	9	3x2'5	10=1000	15	224261	3,80	0,90
22424	Blanca	10	4x2'5	10=1000	10	224247	4,20	0,90
22425	Blanca	12	5x2'5	10=1000	10	224254	4,90	0,90

<b>Grapa de televisión</b>								
22350	Blanca		TV	10=1000	10	223509	4,20	0,90



**PRECIOS X 100 -- UNIDAD DE VENTA = 100 UNIDADES  
CAJAS DE BLÍSTER TODAS LLEVAN 24 BLISTERS**

Código	Color	Medidas	Usar broca			Código	Precio	Precio
						Blíster	Granel	Blíster
<b>Taco-grapa para coaxial RG 6 o manguera 3X1 o cables de similar tamaño. ( de 6,2 a 7,2mm ) Taco 6X22mm</b>								
22450	Blanca	6,7mm.	6mm.	1=100	5	224506	11,60	1,60
22452	Negra	6,7mm.	6mm.	1=100	5	224520	11,60	1,60

<b>Taco-grapa para coaxial RG 11 o manguera 3X1,5 o cables de similar tamaño. ( de 9,8 a 10,7mm ) Taco 6X30mm</b>								
22451	Blanca	6X45	6mm.	1=100	5	224513	14,30	1,60
22453	Negra	6X55	6mm.	1=100	5	224537	14,30	1,60

**Bolsas de 100 piezas.**



Código	Color	Medidas	A pedir			Código	Precio	Precio
						Blíster	Granel	Blíster
<b>Taco con tornillo (montaje fácil)</b>								
22910	gris	5X35	1=100	1X100	4	229105	6,80	1,50
22911	gris	6X35	1=100	1X100	4	229112	6,90	1,50
22912	gris	6X45	1=100	1X100	4	229129	7,80	1,50
22913	gris	6X55	1=100	1X100	4	229136	9,40	1,50
22914	gris	8X45	1=100	1X100	4	229143	14,40	1,50
22915	gris	8X60	1=100	2X50	4	229150	15,60	1,50

**PRECIOS X 100 -- UNIDAD DE VENTA = 100 UNIDADES  
CAJAS DE BLÍSTER TODAS LLEVAN 24 BLISTERS**



Código	Color	medida		Unidad x blíster	Código	Precio Granel	Precio Blíster
					Blíster		
Tacos plástico							
22012	Blanco	5	1000			1,20	
22038	Blanco	7	1000			1,70	
22084	Blanco	12	500			4,70	

**PRECIOS X 100 -- 1 UNIDAD DE VENTA = 100 UNIDADES**



Tacos Nylon							
22087	Gris	4	100	25	220874	2,00	1,20
22095	Gris	5	100	25	220959	2,20	1,20
22103	Gris	6	100	20	221031	2,40	1,20
22111	Gris	8	100	12	221116	3,80	1,20
22129	Gris	10	50	10	221291	6,80	1,20
22136	Gris	12	25	5	221369	14,20	1,20



Código	Medida		Unidad x blíster	Código Blíster	Precio Granel	Precio Blíster
	mm.					
Taco vuelco espárrago						
22142	M-6		25	2	221420	0,64 1,80



Taco vuelco gancho						
22139	M-4		50	2	221390	0,40 1,20

### 100 Bridas de color blancas/negras en bolsa para colgar.

Ratio, UL 94-V2, resistente a la temperatura, -40°C a +85°C. Resistente al aceite, fuel, disolventes, etc.



Código	Medida		P.V.
<b>Blancas</b>		<b>AUTO EXTINGUIBLE</b>	
22505	2,5X100	1=100	<b>0,99</b>
22506	2,5X150	1=100	<b>1,38</b>
22507	2,5X200	1=100	<b>1,76</b>
22510	3,6X150	1=100	<b>2,23</b>
22511	3,6X200	1=100	<b>3,15</b>
22512	3,6X280	1=100	<b>4,60</b>
22519	4,8X160	1=100	<b>3,90</b>
22520	4,8X200	1=100	<b>4,30</b>
22521	4,8X250	1=100	<b>5,40</b>
22522	4,8X300	1=100	<b>6,30</b>
22523	4,8X350	1=100	<b>7,70</b>
22524	4,8X430	1=100	<b>9,90</b>
22551	4,8X500	1=100	<b>11,50</b>
22525	7,6X370	1=100	<b>15,50</b>
22526	7,6X450	1=100	<b>19,00</b>
22527	8,8X610	1=100	<b>36,80</b>
22550	9X760	1=100	<b>43,70</b>
22549	9X920	1=100	<b>53,60</b>



<b>Negras</b>		<b>AUTO EXTINGUIBLE</b>	
22528	2,5X100	1=100	<b>0,99</b>
22529	2,5X150	1=100	<b>1,38</b>
22530	3,6X150	1=100	<b>2,23</b>
22531	3,6X200	1=100	<b>3,15</b>
22532	3,6X280	1=100	<b>4,60</b>
22540	4,8X200	1=100	<b>4,30</b>
22541	4,8X250	1=100	<b>5,40</b>
22542	4,8X300	1=100	<b>6,30</b>
22543	4,8X350	1=100	<b>7,70</b>
22544	4,8X430	1=100	<b>9,90</b>
22545	7,6X370	1=100	<b>15,50</b>
22546	7,6X450	1=100	<b>19,00</b>
22547	9X740	1=101	<b>43,70</b>
22548	9X920	1=100	<b>53,60</b>



Doble

Doble



Precio

Granel

Código	Medidas			Precio Granel
<b>Bridas verdes</b>				
22762	3,6X150	1=100	6	<b>2,40</b>
22763	3,6X200	1=100	6	<b>3,30</b>
22764	3,60X280	1=100	6	<b>4,80</b>



**Bridas extra fuertes negras**

22810	6X180	1=100	6	<b>12,90</b>
22815	6X290	1=100	6	<b>20,20</b>
22818	6X360	1=100	6	<b>26,60</b>
22825	9DX265	1=100	6	<b>23,50</b>
22828	9DX360	1=100	6	<b>35,20</b>

Código	Medidas		Código Blíster	Precio Granel	Precio Blíster
--------	---------	---	----------------	---------------	----------------

Taco para brida

22848	Blanca-6	1=100		<b>5,40</b>	
22849	Negra-6	1=100		<b>5,40</b>	
22850	Negra-8	1=100	228504	<b>5,90</b>	<b>1,00</b>
22851	Blanca-8	1=100	228511	<b>5,90</b>	<b>1,00</b>

- Cada caja lleva 24 blisters.
- El blíster lleva 4 tacos.

Base adhesiva para brida

22860	Blanca	1=100	228603	<b>9,70</b>	<b>1,20</b>
22861	Negra	1=100	228610	<b>9,70</b>	<b>1,20</b>

- Cada caja lleva 24 blisters.
- El blíster lleva 4 piezas.



adhesiva

PVC cortabridas

22501	PVC	6	bolsa		<b>14,60</b>
-------	-----	---	-------	--	--------------





- ✓ Mayor ganancia.
- ✓ Mayor directividad.
- ✓ Mayor relación delante/detrás.

#### ESPECIFICACIONES TÉCNICAS

Recepción canales TDT y TDT HD	
Elementos	43
Canales	21-60
Frecuencia	470-790 MHz
Ganancia	18 dB
Relación delante/detrás	28 dB
Impedancia	75 Ω



**OFERTA**  
**22,90€**

Código: 23195  
Para 10 unidades

Antena TV exterior

Código		P.V.
23195	10	48,90





**3,75€**

Mando universal 10en1  
Mas de 1000 códigos

Presentación en blister.

Código	P.V.
1000018	8,25



**5,75€**

Mando universal 4en1  
Mas de 1000 códigos

Presentación en blister.

Código	P.V.
1000081	12,60



**4,75€**

Mando universal 4en1  
Mas de 1000 códigos

Presentación en blister.

Código	P.V.
2315095	10,90



**5,75€**

Presentación en blister.

Mando universal aire acondicionado  
Mas de 1000 códigos

Código	P.V.
2315100	12,90



**9,90€**

Antena TV interior Md- Air, 230V  
Con amplificador de señal

Código		P.V.
23140	12	18,90



Antena TV interior Md- Space, 230V  
Con amplificador de señal

Código		P.V.
23180	12	22,40

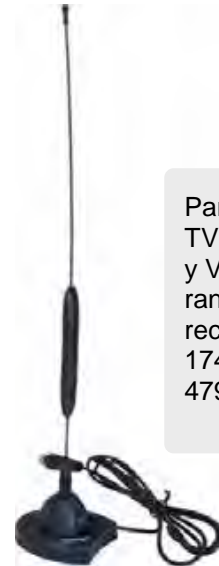

Para recepción TV digital UHF y VHF y radio, rango de recepción : 174 - 230 MHz y 479 - 862 MHz.

Antena TV DVB-T interior

Código		P.V.
09001086	4	12,80



**16,50€**

Antena TV interior 230V  
Con amplificador de señal

Código		P.V.
09001075	4	43,50

- Antena TV Exterior.
- Full HD 1080P
- Kit de montaje incl.
- Recepción horizontal o vertical.
- VHF / FM: 47 - 230 MHz
- UHF: 470 - 860 MHz.
- Impedancia: 75 O.
- Fuente de alimentación: 220V o 5V/100mA.
- Ganancia: 36 dB.
- Con amplificador integrado.



**14,90€**

Antena exterior

Código		P.V.
23160	10	32,50



Base TV-FM empotrar y de superficie

Código		P.V.
23102	10	6,70
231023	10	7,20



- Con control de ganancia.
- De 40 a 875 MHz. , 116 dBuV.
- 1 entrada 2 salidas.

Amplificador de antena

Código		P.V.
23015	10	23,50



Set coaxial 10 pzas.

Código		P.V.
2692322	24	14,60



Conexiones TV acodados

Código		P.V.
23550-1,5m.	10	1,15
23560-2,5m.	10	1,75
23570-5m.	10	2,80
23590-10m.	10	4,85
235502-1,5m.	10	1,55
235601-2,5m.	10	2,15
235700-5m.	10	3,20
235908-10m.	10	5,25



Conexiones TV rectos

Código		P.V.
23660-1,5m.	10	1,15
23670-2,5m.	10	1,75
23680-5m.	10	2,80
23700-10m.	10	4,85
236608-1,5m.	10	1,55
236707-2,5m.	10	2,15
236806-5m.	10	3,20
237001-10m.	10	5,25



Conexiones TV rectos

Código		P.V.
23800-1,5m.	10	1,15
23810-2,5m.	10	1,75
238008-1,5m.	10	1,55
238107-2,5m.	10	2,15



Conexiones digital & 100 Hz. TV con filtro

Código		P.V.
23870-1,5m.	10	2,70
23871-2,5m.	10	3,20
23872-5M.	10	5,60
238701-1,5m.	10	3,10
238718-2,5m.	10	3,60
238725-5m.	10	6,00

Código		P.V.
23875-1,5m.	10	2,70
23876-2,5m.	10	3,20
23877-5M.	10	5,60
238756-1,5m.	10	3,10
238763-2,5m.	10	3,60
238770-5m.	10	6,00



Cable conexión F SAT 1,5 mts.

Código		P.V.
09002138	10	1,90



Cable conexión F SAT 3 mts.

Código		P.V.
09002139	10	2,60

Fichas en ORO



Fichas en ORO



Fichas en ORO



Cable conex. HDMI Oro

Código		P.V.
09001401 1,5m	10	7,90

Cable conex. HDMI 2 mts c/ conector ajustable 180°

Código		P.V.
09004051	6	16,90

Conexión HDMI M-M con filtro

Código		P.V.
26462-1,5m.	10	7,90
26464-3m.	10	11,70



Conexiones macho a "A"  
a macho "A"

Código		P.V.
26110-3m	10	5,20



Conexiones macho a "B"  
a macho "B"

Código		P.V.
26161-3m	10	5,20
26162-5m	10	7,80



Set adaptador USB 7piezas  
1 cable exten. USB 0,75 m

Código		P.V.
09004079	6	14,40



Repartidor inductivo metal

Código		P.V.
23030-1M-2H	25	1,80
23040-1H-2M	25	1,80
230309	25	2,20
230408	25	2,20



Repartidor inductivo metal

Código		P.V.
23042-1M-2H	25	0,98
23044-1H-2M	25	0,98
230422	25	1,38
230446	25	1,38



Repartidor inductivo ficha

Código		P.V.
23090-1H-2M	25	1,10
23091-1M-2H	25	1,10
230903	25	1,50
230910	25	1,50



Conectores TV acodados

Código		P.V.
23092-M	50	0,36
23093-H	50	0,36
230927-M	25	0,76
230934-H	25	0,76
230958-MH	25	1,12



Conectores TV rectos

Código		P.V.
23070-M	50	0,36
23080-H	50	0,36
230705-M	25	0,76
230804-H	25	0,76
230811-MH	25	1,12



Empalmador cable TV

Código		P.V.
23050	50	0,49
230507	25	0,89



Empalme coaxial metal HQ.

Código		P.V.
23240	25	3,30
232402	25	3,70



Conector TV macho

Código		P.V.
23245	25	1,85
232457	25	2,25



Conector TV hembra

Código		P.V.
23246	25	1,85
232464	25	2,25



Separador 1Ent, 2 Sdas.

Código		P.V.
23001	10	3,80
<b>230019</b>	10	4,30



Separador 1Ent, 3 Sdas.

Código		P.V.
23011	10	4,10
<b>230118</b>	10	4,60



Separador 1Ent, 4 Sdas.

Código		P.V.
23021	10	4,30
<b>230217</b>	10	4,80



Repartidor de señal splitters  
Terrestre, 5-1000 MHz.

Código		P.V.	2 VÍAS
23410	6	3,10	
<b>234109</b>	6	3,50	



Repartidor de señal splitters  
Terrestre, 5-1000 MHz.

Código		P.V.	3 VÍAS
23420	6	4,20	
<b>234208</b>	6	4,60	



Repartidor de señal splitters  
Terrestre, 5-1000 MHz.

Código		P.V.	4 VÍAS
23430	6	4,70	
<b>234307</b>	6	5,10	



Repartidor de señal splitters  
Terrestre, 5-1000 MHz.

Código		P.V.	6 VÍAS
23440	6	8,30	
<b>234406</b>	6	8,70	



Repartidor de señal splitters  
Satélite, 5-2450 MHz.

Código		P.V.	2 VÍAS
23500	6	4,60	
<b>235007</b>	6	5,00	



Repartidor de señal splitters  
Satélite, 5-2450 MHz.

Código		P.V.	3 VÍAS
23510	6	5,30	
<b>235106</b>	6	5,70	



Repartidor de señal splitters  
Satélite, 5-2450 MHz.

Código		P.V.	4 VÍAS
23520	6	6,80	
<b>235205</b>	6	7,20	



Mezclador satélite / tierra  
Satélite, 5-2450 MHz.

Código		P.V.	2 VÍAS
23544	6	3,80	
<b>235441</b>	6	4,20	



El blíster lleva 4 piezas.

Conector "F" doble hembra

Código		P.V.
29910	100	0,38
<b>299108</b>	25	1,92



El blíster lleva 1 piezas.

Conector "F" 1mac. 2hemb.

Código		P.V.
29911	50	1,56
<b>299115</b>	25	1,96



El blíster lleva 1 piezas.

Conector "F" 3 hembras

Código		P.V.
29912	50	1,56
<b>299122</b>	25	1,96



El blíster lleva 2 piezas.

Conector "F" rápido macho

Código		P.V.
29897	100	0,85
<b>298972</b>	25	2,10



El blíster lleva 4 piezas.

Conector "F" 6,6mm.

Código		P.V.
29925	100	0,32
<b>299252</b>	25	1,68



El blíster lleva 4 piezas.

Terminal "F" 75 omhs.

Código		P.V.
29891	100	0,40
<b>298910</b>	25	2,00



El blíster lleva 2 piezas.

"F" hembra a pal macho

Código		P.V.
29928	100	1,10
<b>299283</b>	25	2,60



El blíster lleva 1 piezas.

Atenuador de señal

Código		P.V.
23220	25	3,50
<b>232204</b>	25	3,90



El blíster lleva 2 piezas.

Adaptador TV macho a macho

Código		P.V.
29281	50	0,85
<b>292819</b>	25	2,10



El blíster lleva 2 piezas.

Conector TV macho para roscar.

Código		P.V.
29930	50	1,10
<b>299306</b>	25	2,60



El blíster lleva 2 piezas.

Conector TV hembra para roscar.

Código		P.V.
29931	50	1,10
<b>299313</b>	25	2,60



El blíster lleva 2 piezas.

Adaptador TV hembra a hembra

Código		P.V.
29301	50	0,85
<b>293014</b>	25	2,10



CAJA COLOR



Scart box con cable

**Código**  **P.V.**  
26870/ 3h 6 4,70

Scart box con cable

**Código**  **P.V.**  
26875/ 5h 6 6,50

Scart 21 pin 2 tomas c/int. 1,5m.

**Código**  **P.V.**  
26862 10 6,20

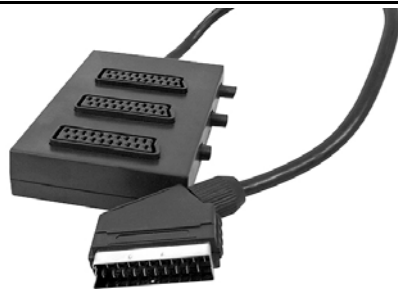

Scart 21 pin 3 tomas c/int. 1,5m.

**Código**  **P.V.**  
26872 10 9,90

Euroconector 21 a 21 pins

**Código**  **P.V.**  
26750 / 1,5m. 12 2,30

Adaptador scart 21 PIN  
3RCA + JACK SVH

**Código**  **P.V.**  
09004060 6 2,60



2 RCA, M a 2 RCA, M

**Código**  **P.V.**  
26010 / 1,5m 10 1,20  
26020 / 2,5m 10 1,50



2 RCA, M a 2 RCA M 2,5mts

**Código**  **P.V.**  
09001150 6 1,60



2 RCA, M a 2 RCA H 1,5mts

**Código**  **P.V.**  
09001156 6 1,60



Set conex. universal 5 pzas.

**Código**  **P.V.**  
09004034 6 5,60



Set conex. universal 5 pzas.

**Código**  **P.V.**  
09004033 6 5,60



Adaptador jack 3,5 a 6,35mm

**Código**  **P.V.**  
09001159 6 1,40





Código		P.V.
Cable USB "A"- "A" 1,80mts		
09004075	6	<b>3,80</b>
USB 2,0		
Cable USB "A"- "B" 1,80mts		
09004076	6	<b>3,95</b>
USB 2,0		
Cable USB M "A"- H "A" 3mts		
09004077	6	<b>4,90</b>
USB 2,0		
Cable UTP. CAT 5e RJ45		
09001254 / 5m.	25	<b>3,40</b>
Cable UTP. CAT 5e RJ45 Conectores blindados		
09002125 / 10m	10	<b>7,80</b>
09002126 / 15m	10	<b>11,80</b>
09002127 / 20m	10	<b>14,80</b>
Cable UTP. CAT 5e		
09001250 / 305m.		<b>108,60</b>
Cable UTP. CAT 6e		
60061 / 305m.		<b>142,80</b>

HEITECH



Soporte universal LCD fijo basculante  
Máx 20KG 10"- 32"

Código			P.V.
09001340		2	19,80



Presentación  
caja color



Soporte universal LCD articul.bascul.  
Máx 20KG 10"- 32"

09001341		1	29,80
----------	--	---	-------



Presentación  
caja color

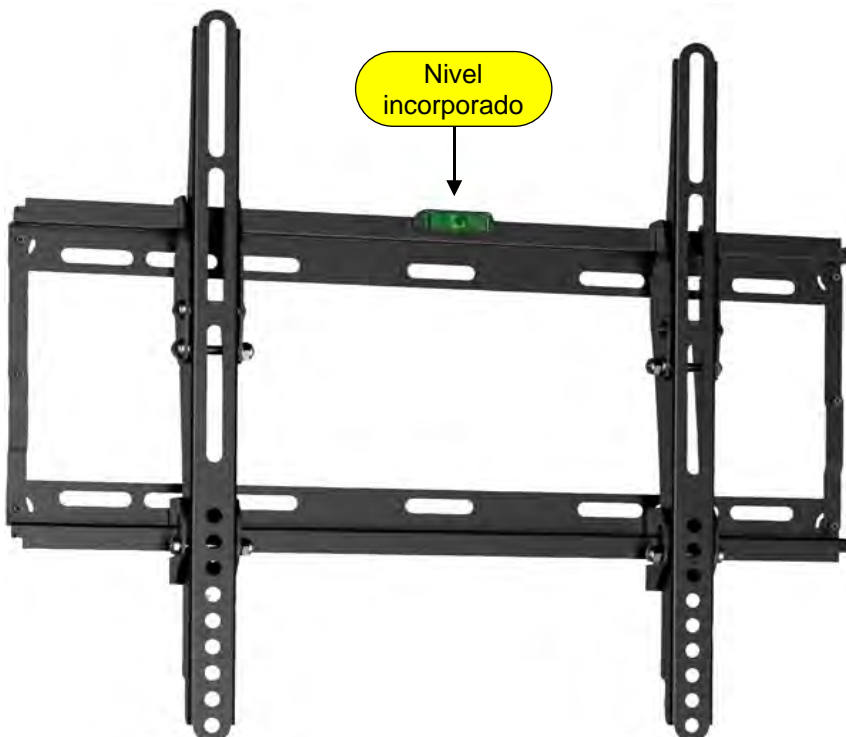

Soporte universal LCD articul.bascul.  
Máx 60KG 32"- 55"

09001343		4	37,40
----------	--	---	-------

- Medidas: 81-140cm.



Kit de accesorios  
incluido.

Presentación  
caja color



Código	Medida	Sección	Color		Precio €
--------	--------	---------	-------	---	----------

Alargo inyectado manguera plana PVC  
con clavija y base de 10A

24039	5	2X0,75	Blanco	10	<b>5,90</b>
24038	5	2X0,75	Negra	10	<b>5,90</b>

Alargo inyectado manguera plana PVC  
con clavija y base de 10A

24032	2	2X1	Blanco	10	<b>3,80</b>
24033	3	2X1	Blanco	10	<b>4,80</b>
24034	4	2X1	Blanco	10	<b>5,80</b>
24035	5	2X1	Blanco	10	<b>7,20</b>
24036	10	2X1	Blanco	10	<b>12,80</b>



Alargo inyectado mang. redonda H05VV-F  
con clavija y base de 16A con protectores

24302	2	3X1	Blanco	10 / 40	<b>4,90</b>
24313	3	3X1'5	Blanco	10 / 40	<b>7,70</b>
24315	5	3X1'5	Blanco	10 / 40	<b>10,60</b>
24320	10	3X1'5	Blanco	6 / 18	<b>18,40</b>



Alargo inyectado mang. redonda H05VV-F  
con clavija y base de 16A con protectores

24322	2	3X1	Negro	10 / 40	<b>4,90</b>
24323	3	3X1'5	Negro	10 / 40	<b>7,70</b>
24325	5	3X1'5	Negro	10 / 40	<b>10,60</b>
24330	10	3X1'5	Negro	6 / 18	<b>18,40</b>



Alargo inyectado mang. redonda H05VV-F  
Manguera H05VV-F 3G 0,75 de 1,8 mts

2470410	0,60	3X1,5	Negro	5	<b>17,60</b>
2470412	0,60	3X1,5	Blanco	5	<b>17,60</b>

Extensible hasta más o menos tres

**VDE** **IP44**

**Garden**

Made in Germany

**as**  
Schwabe  
Technikprodukte

**Außenbereich**  
Outdoor  
www.as-schwabe.de

**TUV**  
**GS**

**CE** 



**2+T**



**3+T**



Código	Medidas	Sección	Color		Precio €
Alargo indust. cetta mang. flex. RV-K 0'6/1KV Clavija y base cetta 16A 220V 2P+T					
24410	10	3X2'5	Negro	5	<b>36,40</b>
24415	15	3X2'5	Negro	6	<b>47,20</b>
24425	25	3X2'5	Negro	4	<b>68,60</b>
24450	50	3X2'5	Negro	2	<b>122,20</b>

Alargo indust. cetta mang. flex. RV-K 0'6/1KV  
Clavija y base cetta 16A 380V 3P+T

24510	10	4X2'5	Negro	5	<b>44,90</b>
24515	15	4X2'5	Negro	6	<b>59,10</b>
24525	25	4X2'5	Negro	4	<b>87,50</b>
24550	50	4X2'5	Negro	2	<b>158,60</b>

**TODOS LOS ARTÍCULOS DE LA PÁGINA VAN  
RETRACTILADOS CON CÓDIGO DE BARRAS**

### Alargo industrial de caucho y neopreno

#### Cable H07RN-F

2460335	15	3X1'5	Negro	1	<b>45,40</b>
2460370	25	3X1'5	Negro	1	<b>71,00</b>
2460375	40	3X1'5	Negro	1	<b>110,40</b>
2460340	50	3X1'5	Negro	1	<b>136,00</b>
2460383	10	3X2,5	Negro	1	<b>47,80</b>
2460384	25	3X2,5	Negro	1	<b>119,60</b>
2460385	33	3X2,5	Negro	1	<b>142,00</b>
2460341	50	3X2,5	Negro	1	<b>199,80</b>

## VDE IP44

#### Manguera goma H07RN-F

2410017	50	3X1'5	Negro	1	<b>126,00</b>
2410020	50	3X2'5	Negro	1	<b>199,00</b>
2410027	50	5X1'5	Negro	1	<b>232,00</b>

- Flexible con conductor de protección.
- Para instalación en industria, construcción y uso agrícola.
- Presentado en bolsa de polipropileno.



Código	Medidas	Sección	Color		Precio €
--------	---------	---------	-------	---	----------

Alargo brico 2X1indust. cetta mang. flex. RV-K 0'6/1KV  
Clavija y base cetta 16A 220V 2P+T

006472	20 mts.	2X1	Naranja	12	23,50
--------	---------	-----	---------	----	-------



Alargo indust. cetta mang. flex. RV-K 0'6/1KV  
Clavija schucko y base cetta salida lateral  
con 1 toma schucko de 16A 220V.

24591	1,5	3X1'5	Negro	6	22,40
24592	15	3X1'5	Negro	6	46,90
24596	25	3X1'5	Negro	4	61,50

**TODOS LOS ARTÍCULOS DE LA PÁGINA VAN  
RETRACTILADOS CON CÓDIGO DE BARRAS**



Convertidor clavija schucko a base cetta

24560	0'30	3X1'5	Negro	5	13,50
24561	1	3X1'5	Negro	5	14,50
24559	1,5	3X1'5	Negro	5	15,50
24562	3	3X1'5	Negro	5	17,40
24576	10	3X1'5	Negro	5	27,60
24563	1	3X2'5	Negro	5	15,30
24574	50	3X2'5	Negro	2	127,60

Convertidor clavija cetta a base schucko

24565	0'30	3X1'5	Negro	5	13,40
24566	1	3X1'5	Negro	5	14,40
24567	3	3X1'5	Negro	5	17,30





Código	Medidas	Sección	Color		Precio €
Alargo industrial manguera goma H07RN-F Clavija más triple de tres tomas goma negro					
24815	15	3X1'5	Negro	1	<b>57,10</b>
24825	25	3X1'5	Negro	1	<b>71,40</b>

**VDE**  
250V 16A



Alargo industrial manguera goma H07RN-F Clavija más triple de tres tomas goma negro					
2460459	50	3X1'5	Negro	1	<b>167,20</b>

**VDE**  
250V 16A



Alargo manguera H05VV-F					
2451013	10	3X1'5	Naranja	1	<b>22,40</b>
2451153	15	3X1'5	Naranja	1	<b>29,70</b>
2451160	20	3X1'5	Naranja	1	<b>38,90</b>

Clavija y base 16A 250V.

**VDE**  
250V 16A





Código	Medida	Sección	Color		Precio €
Alargo inyectado mang. redonda H07RN-F con clavija 16A <b>MANGUERA RN</b>					
2470556	3m.	2X1,5	Negro	10	10,70
Alargo inyectado mang. plana H03VVH2-F con clavija 10A					
006907	1,50m.	2x0,75	Blanco	10	3,50
Alargo inyectado mang. redonda H05VV-F con clavija 16A					
009295	1,80m.	3X1	Blanco	10	4,20
2470833	3m.	3X1	Blanco	10	5,90
009296	1,80m.	3X1	Negro	10	4,20
2470832	3m.	3X1	Negro	10	5,90
Alargo inyectado <b>manguera H07RN-F</b> redonda con clavija 16A					
2460376	3m.	3X1	Negro	10	8,60
2460377	1,5m.	3X1,5	Negro	10	4,90
2460379	4,5m.	3X1,5	Negro	10	15,80
Conexión doble guía. Manguera H03VVH-2-F					
26905	1,8	2X0,5	Negro	10	3,10
Conexión doble guía RIZADA. Manguera H03VVH-2-F					
26906	1,8	2X0,5	Negro	10	3,10
Conexión de RED a CPU. Manguera H05VV-F 3G 0,75 de 1,8 mts					
26911	1,8	3X0,75	Negro	10	5,60
Alargo conexión plancha cable textil H05VV-F con clavija 16A					
24045	2m.	3X0,75	Negro	10	6,40

# TIMBRES







Precio €

Oferta

Cajas com.

Código	Medida		Precio € Tarifa	Oferta Cajas com.
<b>Timbre zumbador</b>				
25605	45x61x36	20	4,20 €	1,95

- Tensión 220V-240V sólo en corriente alterna.



**Timbre Classic**

25610	80x130x50	6/24	8,40 €	3,95 €
-------	-----------	------	--------	--------

- Tensión 230V sólo en corriente alterna.



**Timbre Orión**

25620	115x115x45	6	9,80 €	4,60 €
-------	------------	---	--------	--------

- Tensión 110V-240V sólo en corriente alterna.  
- Timbre de 2 notas electromecánico.



**Timbre Aries**

25625	168x103x50	6	10,50 €	4,90 €
-------	------------	---	---------	--------

- Tensión 110V-240V sólo en corriente alterna.



**Timbre Perseo**

25630	168x103x50	6	10,50	4,90 €
-------	------------	---	-------	--------

- Tensión 110V-240V sólo en corriente alterna.





Código	Medida		Precio € Tarifa	Precio € Oferta Cajas com.
<b>Timbre inalámbrico Draco 50 m.</b>				
25660	90x140x40	6	17,60 €	8,20 €

- Funciona con 3 pilas LR14 (no incluidas).
- También puede ser usado como buscapersonas o alarma anti-pánico.
- Evita interferencias con radio telecomunicaciones.



<b>Timbre inalámbrico Lyra 100 m.</b>				
25665	120x160x55	6	24,50 €	11,40 €

- Tres tipos de sonidos diferentes.
- Funciona con 3 pilas LR14 (no incluidas).
- También puede ser usado como buscapersonas o alarma anti-pánico.
- Evita interferencias con radio telecomunicaciones.



<b>Timbre y luz inalámbrico 100 m.</b>				
25670	120x160x55	6	26,50 €	12,40 €

- Tres tipos de sonidos diferentes.
- Funciona con 3 pilas LR14 (no incluidas).
- También puede ser usado como buscapersonas o alarma anti-pánico.
- Evita interferencias con radio telecomunicaciones.



**Especial para personas sordas**

Precio €

Precio €  
Tarifa

Oferta  
Cajas com.

Código	Medida		Precio € Tarifa	Oferta Cajas com.
Timbre inalámbrico 150 m.				
HL452	100x70	6	14,90 €	6,95 €



- Funciona con 2 pilas AA incluidas.
- También puede ser usado como buscapersonas o alarma anti-pánico. 38 sonidos a elegir
- Evita interferencias con radio telecomunicaciones.



Timbre inalámbrico 150 m.

HL453	100x70	6	14,90 €	6,95 €
-------	--------	---	---------	--------



- Tres tipos de sonidos diferentes.
- Funciona con 3 pilas AA incluidas
- También puede ser usado como buscapersonas o alarma anti-pánico. 38 sonidos a elegir
- Evita interferencias con radio telecomunicaciones.



Timbre inalámbrico 120 m.

HL457	106x65	6	15,60 €	7,30 €
-------	--------	---	---------	--------



- Tres tipos de sonidos diferentes.
- Funciona con 3 pilas AA incluidas
- También puede ser usado como buscapersonas o alarma anti-pánico. 38 sonidos a elegir
- Evita interferencias con radio telecomunicaciones.





Código	Diametro		Precio €	Precio €
			Tarifa	Oferta Cajas com.
Timbre industrial 220V				
25680	10cm	20	10,80 €	4,90 €

- 85dB
- Peso 350grs

Timbre industrial 220V

25681	15cm	10	21,80 €	9,90 €
-------	------	----	---------	--------

- 95dB
- Peso 900grs



COLORES SURTIDOS



COLORES SURTIDOS



Código			Precio €
--------	--	--	----------

Auriculares stéreo. Silicona

2676696	Blanco	12/48	2,25
---------	--------	-------	------

- Digital Jack de 3,5.



Auriculares stéreo.

2676697	Surtido	12/48	2,60
---------	---------	-------	------

- Digital Jack de 3,5.  
- Circuito boble acústico para mp3.

Auriculares stéreo.

09001392	Surtido	10	4,40
----------	---------	----	------

- Digital Jack de 3,5.  
- Circuito boble acústico para mp3.

Auriculares stéreo.

09001393	Surtido	10	12,30
----------	---------	----	-------

- Digital Jack de 3,5.  
- Microfono para moviles incorporado

Auriculares stéreo.

09001394	Surtido	10	12,30
----------	---------	----	-------

- Digital Jack de 3,5.  
- Circuito boble acústico para mp3.  
- Con funda de transporte



Código			Precio €
--------	--	--	----------

Auriculares stéreo. Cable 2,1m.			
26100	Surtido	20	3,40

- Digital Jack de 3,5.
- Ajuste perfecto.

Auriculares stéreo. Cable 2,1m.			
26105	Surtido	20	3,40

- Digital Jack de 2,5 - 3,5.
- Ajuste perfecto.

Auriculares stéreo. Mini			
09001390	Surtido	10	4,40

- Digital Jack de 3,5 más adaptador 6,3.



Auriculares stéreo. Deportivos			
09001391	Surtido	10	4,20

- Digital Jack de 3,5.
- Acople perfecto a la oreja.

Auriculares stéreo <b>bluetooth</b> c/ microfono			
2622207	Surtido	6	43,90

- Autonomía 8 h. En conversación.
- Autonomía 12 h. Escuchando música.
- Autonomía 100h. En inactividad.
- Batería de 330mAh.
- Alcance 10 mts.

**OFERTA 19,90€**

Auriculares stéreo			
09001346	Surtido	10	11,90

- Digital Jack de 3,5.
- Con funda de transporte.





Código			Precio €
Set 4 velas con baterías			
04000378		6/120	<b>4,60</b>



- 4 velas led luz cálida.
- Interruptor de apagado y encendido.
- 3 baterías AG3 (incluidas).



Set 6 velas con baterías			
2041960	EXP 30 SETS	1	<b>4,95</b>



- Set 6 velas led luz cálida.
- Interruptor de apagado y encendido.
- 1 batería CR2032 (incluida).



Set 3 enchufes con control remoto			
010010		2/10	<b>38,80</b>

- Con led de funcionamiento.
- Con código ajustable individualmente.
- Máximo 1000W.
- Alcance del mando 25 mts.



Set 2 alarmas de ventana con ON/OFF			
04002627		6/48	<b>5,95</b>



- Sirena de 90 dB.
- Baterías incluidas.



Set 2 Lámparas E14 7W 230V			
04002503		10	<b>2,60</b>

- Especiales para apliques luz noche.



Precio € oferta

Código			Precio €	oferta
Alimentador universal				
009522	500mA.	60	11,90	5,60
009521	1000mA.	60	13,90	6,50

6 JACKS



6 JACKS



Alimentador universal ESTABILIZADO				
09001550	600mA.	5	16,90	8,20
600mA. Con 6 Jacks				

Alimentador universal ESTABILIZADO				
09001551	1000mA.	5	18,90	9,20
Digital Jack de 2,5 - 3,5				



Alimentador universal ESTABILIZADO				
060101	300mA.	6	12,90	5,90
100-240V Con 6 Jacks				



Alimentador universal ESTABILIZADO				
060125	1800mA.	6	21,90	9,90
100-240V Con 6 Jacks + USB				

Alimentador universal ESTABILIZADO				
060126	2500mA.	6	25,90	11,90
100-240V Con 6 Jacks + USB + 3 conex. Para SONY				





Código			Precio €	Precio oferta
Acumulador de carga reserva móviles Power bank				
2622265	1800mAh	48	8,90	3,90
26895	2600mAh	6	9,90	4,90

- Incluye adaptador USB.



Acumulador de carga reserva móviles Power bank				
05001689	2600mAh	4	17,50	6,95

- Incluye adaptador USB.



Cargador móviles, Smartphone, MP3				
05001655		6/60	12,40	5,60

- Corriente AC 100-240V, 50-60Hz.  
- Salida USB 5V / 1A.



Cargador ideal para Tablet-PC ó Smartphone				
05001670		4/48	24,70	11,90

- Corriente AC 100-240V, 0,5A.  
- Salida 5V DC - 3,4A ( 1USB-2,4A y 1USB 1A ).  
- Pueden trabajar simultáneamente  
- Con led operativo.



Cargador ideal para Tablet-PC ó Smartphone				
04002267		6/60	18,50	8,40



Cargador coche USB + 1 toma libre USB 1A				
05001652		6/60	19,60	8,90



Cargador de coche para PDA, MP3, Móviles				
05001628		10/60	6,90	3,20

- Corriente 12-24V - DC.  
- Salida 5V DC. Máximo

Cargador de coche para PDA, MP3, Móviles				
05001629		4/48	12,90	6,40

- Corriente 12-24V - DC.  
- Salida 5V DC ( 2X1A ó 1 de 2A ).Máximo 1A.

# MINI POD 3 LED



Código		P.V.
Luz armarios y multiusos 6,5cm.		
27110	12	3,80

- 3 Led de luz blanca brillante.
- Presionando enciende y apaga.
- Adhesivo en la trasera.
- Utiliza 3 baterías LR03 (no incluidas).

**oferta**  
**1,20€**

# MINI POD 39 LED



Caja expositora, Mini pod 39 LEDS		
27131	16	7,40

- Utiliza 3 baterías LR03 (no incluidas).

### POSICIONES:

- ON/24 LEDS exteriores de luz roja.
- 15 LEDS centrales de luz blanca.
- 24 LEDS exteriores de luz roja intermitente.
- OFF.

**oferta**  
**3,40€**



**CON IMÁN  
Y PERCHA  
PARA COLGAR**



oferta  
1,75€



oferta  
4,15€



oferta  
4,65€

Código		Precio €
Luz armarios y multiusos 15 cm.		
27115	12	4,20

- 4 leds de luz blanca brillante.
- Ahorra el 85% de energía, no emite rayos U.V.
- Regulador de tiempo de encendido hasta 30 seg.
- Utiliza 4 baterías LR06 (no incluidas).



Luz camping, etc 23 LED con interruptor		
20056	6	8,90

- Con adhesivo en la trasera.
- Utiliza 4 baterías LR06 (no incluidas).



Luz camping, etc 28 LED con interruptor		
20057	6	10,90

- Con colgador o para tubo de 38 mm.
- Utiliza 4 baterías LR06 (no incluidas).
- Medidas: 160mm.





**oferta**  
**2,10€**



**oferta**  
**5,40€**



**oferta**  
**6,50€**



**oferta**  
**4,95€**



**oferta**  
**5,95€**



**oferta**  
**8,90€**

Código		Precio €
Luz noche led		
2741345	12	4,50
- Consumo 0,5W.		
Luz noche led Set 2 unidades		
2741344	12	11,90
- Botón on/off.		
Adaptador schucko con luz led		
04002314	10/50	14,90
- Con led de funcionamiento. - Incluye interruptor día/noche crepuscular 10 lux. - Consumo 0,8W.		
Luz noche led		
04002290	6/60	10,90
- Incluye interruptor día/noche crepuscular 10 lux. - Consumo 0,8W.		
Luz noche led c/ toma schucko		
04002293	10/100	12,90
- Incluye interruptor día/noche crepuscular 10 lux. - Consumo 0,8W.		
Luz noche led		
04002925	4/48	20,40
- Con sensor de movimiento. - Se apaga sólo al minuto de no detectar movimiento. - Interruptor de on/off. - Baterías 3 X AAA ( no incluidas ).		



1,75€



1,75€



1,95€



1,55€



3,90€

Código			Precio €
--------	--	---	----------

Luz noche c/interruptor 1W			
27100	Blanco	12	4,20



Luz noche c/interruptor 1W			
27102	Blanco	12	4,20



Luz noche c/interruptor			
27108	Blanco	10	4,40

- Lámpara E14 7W.



Luz noche c/sensor luz			
27109	Blanco	10	4,90

- Lámpara E14 7W.



Luz noche 4 leds de 0,4W			
HL991L	Blanco	12	3,30

- 4 Colores de luz surtidos.



Regulador pasador de luz			
27405	Blanco	10	8,40

- Fabricado con materialV0, ROHS.
- Con filtro antiparásito, y filtro EMC.
- Apto para cargas de incandescencia y halógenas.
- De 25W a 200W.



6,90€



4,75€



7,20€



6,90€



Código			Precio €
<b>Detector de movimiento 360° con tres detectores máx. 1200W</b>			
27535	Blanco	10	14,90

- Voltaje 220-250V AC.
- Frecuencia 50-60Hz.
- Luz ambiente <10 a luz día ajustable.
- Tiempo de duración de 5 seg. a 8 min. Ajustable.
- Detección de movimiento hasta 6 mts.
- Altura de instalación de 2 a 4,5 mts.
- Interruptor crepuscular.
- Protección clase II/IPX3.

**Detector de Movimiento 180° para pared Max. 1200W**

27540	Blanco	10	11,60
27541	Negro	10	11,60

- Voltaje 220-250V AC.
- Frecuencia 50-60Hz.
- Luz ambiente <10 a luz día ajustable.
- Tiempo de duración de 5 seg. a 8 min. Ajustable.
- Detección de movimiento hasta 12 mts.
- Altura de instalación de 0,5 a 3,5 mts.
- Interruptor crepuscular.
- Protección clase II/IPX3.

**Detector de Movimiento 180°**

27525	Blanco	10	14,90
-------	--------	----	-------

- Voltaje 220-250V AC.
- Frecuencia 50-60Hz.
- Luz ambiente <10 a luz día ajustable.
- Tiempo de duración de 5 seg. a 8 min. Ajustable.
- Detección de movimiento hasta 8 mts.
- Altura de instalación de 1,5 a 3,5 mts.
- Interruptor crepuscular.
- Protección clase II/IPX3.

Presentación en caja

**Detector de Movimiento 180°**

HL481B	Blanco	10	14,90
--------	--------	----	-------

- Voltaje 220-250V AC.
- Frecuencia 50-60Hz.
- Luz ambiente <10 a luz día ajustable.
- Tiempo de duración de 5 seg. a 8 min. Ajustable.
- Detección de movimiento hasta 12 mts.
- Altura de instalación de 0,5 a 3,5 mts.
- Interruptor crepuscular.
- Protección clase II/IPX3.

Presentación en caja



11,95€

Código	Color		Precio €
Detector de movimiento por infrarrojos Máx.. 1000W			<b>180°</b>
2743801	Blanco	10	<b>23,70</b>

- Zona de detección 12m.



12,95€

Detector de movimiento por infrarrojos Máx. 1300W			<b>360°</b>
2743811	Blanco	10	<b>27,80</b>

- Zona de detección 16m.
- Tiempo de iluminado ajustable de 5 seg. a 12 min.
- Posibilidad de iluminación permanente.
- Interruptor crepuscular ajustable.
- Protección clasell.
- Uso exterior.



5,75€

Detector de Movimiento 360° Max.800W <b>MINI</b>			
27544	Blanco	10	<b>12,90</b>

- Voltaje 220-250V AC.50Hz. Max. 1200W
- Luz ambiente <3 a 2000 luz día ajustable.
- Tiempo de duración de 7 seg. a 10 min. Ajustable.
- Detección de movimiento hasta 6 mts. a 24°C
- Altura de instalación de 2,2 a 4 mts.
- Interruptor crepuscular.
- Protección clase II/IPX3. IP20.



5,30€

Detector de Movimiento de 120° a 360° Max.800W <b>Micro</b>			
27545	Blanco	10	<b>11,90</b>

- Voltaje 220-250V AC. 50-60Hz.
- Luz ambiente <10 a luz día ajustable.
- Tiempo de duración de 5 seg. a 8 min. Ajustable.
- Detección de movimiento de 3 a 6 mts. a 24°C
- Altura de instalación de 1,8 a 2,5 mts. en pared
- Altura de instalación de 2,2 a 4 mts. en techo
- Interruptor crepuscular.
- Protección clase II/IPX3. IP20



7,60€



Detector de Movimiento por infrarrojos 360° Max. 1200W			
27542	Blanco	5	<b>19,90</b>

- Voltaje 220-250V AC. 50-60Hz.
- Luz ambiente <3 a luz día ajustable.
- Tiempo de duración de 3 seg. a 7 min. Ajustable.
- Detección de movimiento hasta 12 mts.
- Interruptor crepuscular.
- Protección clase II/IP3. IP65

**DETECTA A TRAVÉS DE PUERTAS, CRISTALES, TECHOS...**



**9,60€**



**6,70€**



**7,25€**



**9,90€**

Código			Precio €
<b>Detector de movimiento 360° MICRO ONDAS</b>			
27547	Blanco	10	<b>21,90</b>

- Detector de movimiento 360°
- Voltaje 220-240V / 50-60Hz.
- Distancia de detección 12 mts.
- Tiempo de programación de 3seg. -12min.
- Lux ajustables de 3 a 2000
- Máx. 1200W y fluorescencia max. 300W.

<b>Detector de movimiento por infrarrojos Máx.. 500W</b>			
27546	Blanco	10	<b>15,90</b>

- 220-240V 50Hz.
- Voltaje 220-250V AC. Frecuencia 50-60 Hz.
- Luz ambiente < 10 a luz día ajustable.
- Tiempo de duración de 5 seg. a 10 min. Ajustable.
- Detección de movimiento máx. 6 mts.
- Máx. 500W.

<b>Alarma de detector de humos</b>			
27600	Blanco	10	<b>22,90</b>

- Volumen de la alarma 85db.
- Batería 9V (no incluida).







<b>Alarma detector de Gas</b>			
27415	Blanco	10	<b>21,70</b>

- Detecta todos los gases licuados de petroleo (GLP)
- Volumen de la alarma 80db.
- Incorporada sda. cable para extractor.

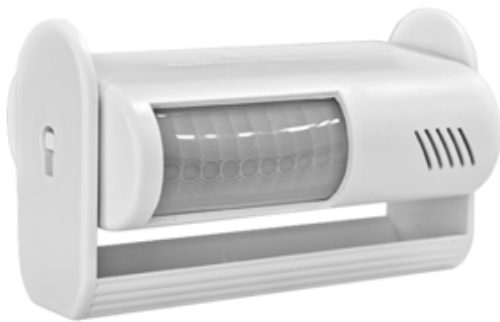
**Presentación en blister**





Código			Precio €
<b>Interrupor crepuscular</b>			
27050	6Amp.	10	12,60
<ul style="list-style-type: none"> <li>- Sensibilidad 50 Lux.</li> <li>- 220-240V 50-60Hz.</li> <li>- IP44.</li> </ul>			
<b>Interrupor crepuscular</b>			
27051	10Amp.	10	14,60
<ul style="list-style-type: none"> <li>- Sensibilidad 50 Lux.</li> <li>- 220-240V 50-60Hz.</li> <li>- IP44.</li> </ul>			
<b>Interrupor crepuscular</b>			
27052	25Amp.	10	14,60
<ul style="list-style-type: none"> <li>- Sensibilidad 50 Lux.</li> <li>- 220-240V 50-60Hz.</li> <li>- IP44.</li> </ul>			
<b>Mini sensor alarma 60°</b>			
27455	Blanco	10	18,60
<ul style="list-style-type: none"> <li>- 220-240V 50Hz.</li> <li>- Batería 9V (Incluída).</li> <li>- Tiempo de alarma 10 seg.</li> <li>- Intensidad de alarma 80 db.</li> <li>- Interruptor función ON/OFF.</li> <li>- Detección de movimiento hasta 8 mts.</li> </ul>			
 			
<b>Timbre alarma avisador</b>			
HL454	Blanco	6	17,20
<ul style="list-style-type: none"> <li>- Funciona con 3 baterías LR03-AA.</li> <li>- Detección 6 mts., ángulo de detección 110°.</li> <li>- Nivel de sonido alarma 60db.</li> <li>- Sonido timbre ding dong.</li> <li>- Interruptor ON/OFF-alarma-timbre.</li> <li>- Medida 90X80X40.</li> </ul>			



2,45€



4,95€



3,35€



3,85€

Código



Precio €

Reloj programador horario 24 H.

27352

10

6,60

- Mecánico.
- 220-240V 50Hz.
- Máx. 3500W.

Reloj programador digital semanal

27357

10

13,60

- Batería auto recargable.
- 220-240V 50Hz.
- Máx. 3500W.

Reloj programador horario 24 H.

27353

10

8,40

- Mecánico.
- 220-240V 50Hz.
- Máx. 3500W.

Reloj programador horario 24 H.

27354

10

8,20



Código	Amperios		Código blíster	Precio tarifa	Precio blíster
<b>Interruptor unipolar</b>					
28010	10	12	280106	3,50	4,10
28016	16	12	280168	3,50	4,10
28020	20	12	280205	3,50	4,10
28025	25	12	280250	3,50	4,10

- Tensión 230/400V.
- Frecuencia 50/60 Hz.
- Sección de conexionado 1 a 25 mm.
- Fijación a carril.
- Normas IEC 60898.

#### Mini magnetotérmicos 18mm.Unipolar+Neutro

28060	10	12	280601	5,90	6,50
28066	16	12	280663	5,90	6,50
28070	20	12	280700	5,90	6,50
28075	25	12	280755	5,90	6,50
28082	32	12	280823	5,90	6,50

- Tensión 230/400V.
- Frecuencia 50/60 Hz.
- Sección de conexionado 1 a 25 mm.
- Fijación a carril.
- Normas IEC 60898.

#### Magnetotérmicos 36mm.Unipolar+Neutro

28310	10	12	283103	7,20	7,60
28316	16	12	283169	7,20	7,60
28320	20	12	283206	7,20	7,60
28325	25	12	283251	7,80	8,40
28332	32	12	283329	9,60	10,20
28340	40	12	283404	9,60	10,20

- Tensión 230V.
- Polos 1+N.
- Normas IEC 60898.
- Frecuencia 50/60 Hz.
- Fijación a carril.

#### Interruptor diferencial

28725	25	6	287259	24,80	25,40
28740	40	6	287402	26,80	27,40

- Tensión 230V.
- Polos 1+N.
- I<sub>an</sub> 0.03A.
- Normas IEC 61008-1.
- Frecuencia 50/60 Hz.
- Fijación a carril.



Código	Potencia máx.		Precio €
<b>Minutero de escalera mecánico</b>			
27922	2300W	6	16,50

- 16A 220-240V. 50Hz/60Hz.
- Conexión 3 o 4 cables.
- Tipo de contactos mecánico.
- Tiempo reg. De 1 min. a 7 min.
- Montaje a carril DIC 46277.
- Medidas: 66X17,5X84.

#### Interruptor horario

27927	c/reserva 150h.	6	44,80
27928	sin reserva	6	39,60

- Esfera de 24h. Maniobra mínima 30 min.
- 230V/45-60Hz. Movimiento de cuarzo.
- Bornes de conexión a tornillos de 3.8 mm.
- Interruptor ON-OFF o automático.
- Normativas europeas:  
EMV/CEN/EMC/ETY 73/23EEC y 89/336/EEC
- Medidas: 90X54X65 Fijación a carril.

27926	tapa y fijación	6	0,90
-------	-----------------	---	------

- La tapa y la fijación para fuera de carril son optativas y se piden a parte.

#### Interruptor horario mini

27925	c/reserva 72h.	6	54,60
-------	----------------	---	-------

- Igual que el anterior pero con las medidas más peq.
- Medidas: 90mm X 18mm fondo 65 mm.
- Fijación a carril un módulo.

#### Interruptor horario mini

27385		6	22,60
-------	--	---	-------

- Esfera de 24h. Maniobra mínima 15 min.
- 230V/50Hz. MAX. 3500W
- Bornes de conexión a tornillos de 3.8 mm.
- 48 ON-OFF Pogramas
- Normativas europeas: CE
- Medidas: 90X17,5X61,5 Fijación a carril.

# EXPOSITOR FUSIBLES

**CÓDIGO:  
98051**



COD.	CANT.
30144	100
30151	100
30169	100
30177	100
30185	100
30193	100
30306	50
30310	50

COD.	CANT.
30316	50
30910	50
30916	50
30920	50
30101	30
30102	30
30104	30
30106	30

COD.	CANT.
30110	30
30116	30
30120	30
30125	30
30206	20
30210	20
30216	20
30220	20

COD.	CANT.
30225	20
30232	20
30416	5
30420	5
30425	5
30432	5
30440	5
30450	5

# 5x20

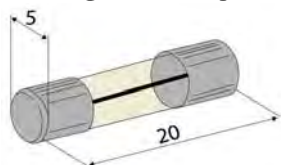

# 6,3x32

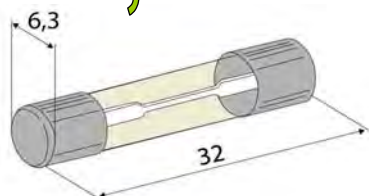

Código	Amp.		Unidad x blister	Código blister	Precio granel	Precio blister
Fusible de cristal 5x20					granel	Blister
30144	500 mA	100	5	301443	0,22	1,40
30151	2 A	100	5	301511	0,22	1,40
30169	4 A	100	5	301696	0,22	1,40
30177	6 A	100	5	301771	0,22	1,40
30185	10 A	100	5	301856	0,22	1,40
30193	16 A	100	5	301930	0,22	1,40

### Fusible de cristal 6'3x32

30306	6 A	100	3	303065	0,35	1,40
30310	10 A	100	3	303102	0,35	1,40
30316	16 A	100	3	303164	0,35	1,40

### Fusible Metrópoli

30910	10 A	25	2	309104	0,52	1,40
30916	16 A	25	2	309166	0,52	1,40
30920	20 A	25	2	309203	0,52	1,40

### Fusible cartucho gl serie 831 8'5x31

30101	1A	10			1,48	
30102	2A	10			1,10	
30104	4A	20			1,10	
30106	6A	10			1,10	
30110	10A	10			1,10	
30116	16A	10			1,10	
30120	20A	20			1,10	
30125	25A	10			1,10	

### Fusible cartucho gl C20 10X38.

30206	6A	10			1,30	
30210	10A	10			1,30	
30216	16A	10			1,30	
30220	20A	10			1,30	
30225	25A	10			1,30	
30232	32A	20			1,30	

**Todas las cajas llevan 24 blisters**

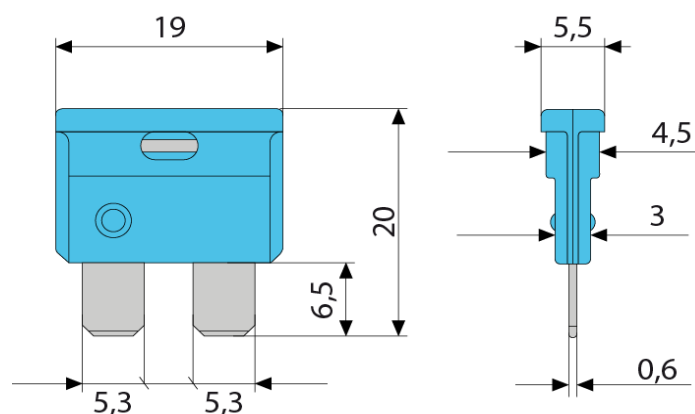

Código	Amp.		Precio granel
<b>Fusible cartucho gl C40 14X51.</b>			
30410	10A	10	1,70
30416	16A	10	1,70
30420	20A	10	1,70
30425	25A	10	1,70
30432	32A	10	1,90
30440	40A	10	1,90
30450	50A	10	2,98
<b>Fusible cartucho gl C80 22X58.</b>			
30832	32A	10	3,10
30840	40A	10	3,10
30850	50A	10	3,30
30863	63A	10	3,30
30880	80A	10	3,70
<b>Fusible cartucho Neozed</b>			
30957	16A	10	2,10
30958	20A	10	2,10
30959	25A	10	2,10
30960	35A	10	2,10
30961	50A	10	2,30
30962	63A	10	2,30
30963	80A	10	9,20
<b>Fusible ficha coche universal</b>			
30985	 30 A	100	0,15
30987	 5 A	100	0,15
30988	 7,5 A	100	0,15
30989	 10 A	100	0,15
30990	 15 A	100	0,15
30991	 20 A	100	0,15
30992	 25 A	100	0,15
30993	 30 A	100	0,15
30994	SURTIDO EN BLISTER 2 DE CADA 16		2,70

Todas las cajas llevan 24 blisters



Conector modular 4P4C RJ 10  
El blíster lleva 12 piezas

Código		P.V.
35020	100	0,10
350205	25	1,20



Conector modular 6P4C RJ 11  
El blíster lleva 12 piezas

Código		P.V.
35040	100	0,10
350403	25	1,20



Conector modular 6P6C RJ 12  
El blíster lleva 6 piezas

Código		P.V.
35050	100	0,15



Conector modular 8P8C RJ 45  
El blíster lleva 6 piezas

Código		P.V.
35060	100	0,15
350601	25	1,20



**Blindado**  
Conector modular 8P8C RJ 45

Código		P.V.
35063	100	0,26



Empalme teléfono 1H - 1H

Código		P.V.
35070	25	0,70
350700	25	1,00



Ladrón teléfono 1M - 2H

Código		P.V.
35130	25	0,86
351301	25	1,16



Ladrón teléfono 1M - 3H

Código		P.V.
35170	25	1,50
351707	25	1,80



Base teléfono mini superficie

Código		P.V.
35210	24	1,10
352100	24	1,40



Base teléfono MD-teléfonica

Código		P.V.
35211	24	2,00
352117	24	2,40



Cable tlf. 2 hilos paralelo rollito 15 mt.

Código		P.V.
35301	10	3,90





**Alargo teléfono M-M**

Código		P.V.
Blanco 2,10 mts.		
35360	10	<b>0,90</b>
<b>353602</b>	10	<b>1,20</b>
Blanco 4,50 mts.		
35370	10	<b>1,60</b>
<b>353701</b>	10	<b>1,90</b>



**Alargo teléfono M-M**

Código		P.V.
Blanco 7,50 mts.		
35410	10	<b>2,50</b>
<b>354104</b>	10	<b>2,80</b>
Blanco 10 mts.		
35430	10	<b>3,20</b>
<b>354302</b>	10	<b>3,50</b>



**Alargo teléfono 1M-1H**

Código		P.V.
Blanco 2,10 mts.		
35600	10	<b>1,40</b>
<b>356009</b>	10	<b>1,70</b>
Blanco 4,50 mts.		
35610	10	<b>1,80</b>
<b>356108</b>	10	<b>2,10</b>



**Timbre teléfono con luz flash**

Código		P.V.
35720	6	<b>12,80</b>



**Tenazas de crimpar 6P4C - 6P6C**



Código		P.V.
35270	10	<b>7,60</b>

**Tenaza de Crimpar 6P4C-6P6C-8P8C**

Código		P.V.
35342	10	<b>16,80</b>



**Universal todos los RJ**





Código		P.V.
35343	10	<b>21,80</b>

Código	Medidas			Blíster	Precio Granel	Precio Blíster
<b>Regletas de conexión P.E blancas</b>						
36012	4 mm	10	1	360129	0,60	1,00
36020	6 mm	10	1	360204	0,70	1,10
36038	10 mm	10	1	360389	1,00	1,40
36046	16 mm	10	1/2	360464	1,80	1,30
36053	25 mm	10	1/3	360532	3,60	1,60

<b>Regletas de conexión P.E. negras</b>						
36269	4 mm	10	1	362697	0,60	1,00
36277	6 mm	10	1	362772	0,70	1,10
36285	10 mm	10	1	362857	1,00	1,40
36293	16 mm	10	1/2	362932	1,80	1,30
36301	25 mm	10	1/3	363014	3,60	1,60

Todos los blíster van en cajas de 24.

Código	Modelo		Precio X tira
<b>Regletas unipolares de conexión</b>			
36510	2'5 mm	25 Tiras de 10	2,30
36511	4 mm	25 Tiras de 10	2,70
36512	6 mm	25 Tiras de 10	3,20
36513	10 mm	10 Tiras de 10	5,60
36514	16 mm	5 Tiras de 10	4,80

Código	Medidas	Cantidad	Precio X pz.
<b>Conectores a rosca con muelle</b>			
 36426	2x1'5mm	Bolsas de 100	0,18
 36427	2x2'5mm	Bolsas de 100	0,24
 36428	2x6mm	Bolsas de 100	0,48
 36429	2x10mm	Bolsas de 100	0,56

Código	Medidas	Cantidad	Polos	X pz.
<b>Regletas unipolares de conexión</b>				
36310	0,2 a 1'5mm	Bolsas de 100	2 - 5A	0,14
36311	0,5 a 2'5mm	Bolsas de 100	2 - 10A	0,20
36312	1,5 a 6mm	Bolsas de 100	2 - 25A	0,52
36315	0,2 a 1'5mm	Bolsas de 100	3 - 5A	0,22
36316	0,5 a 2'5mm	Bolsas de 100	3 - 10A	0,32
36317	1,5 a 6mm	Bolsas de 100	3 - 25A	0,80

- Conexión rápida sin tornillos
- Libre de halógenos.

Código	Medidas	Cantidad	Características	Precio X pz.
<b>Conectores a presión</b>				
36303	Flex. 0,5 a 4mm	50	para 3	0,45
36305	Rig. 0,5 a 2,5mm	25	para 5	0,70

- Conexión rápida.
- 24A - 450V
- Libre de halógenos.

# ENROLLACABLES MANGUERA NEGRA

con protector  
de sobrecarga





**6,95€**  
**8,95€**



**8,95€**  
**10,90€**  
**11,95€**  
**12,20€**



**14,95€**  
**16,95€**

Código	Sección	Metros		Precio €
Enrollables con protector sobretensión.				
010664	3X1	3 mts	20	13,50
010665	3X1	5 mts	20	16,80

- Con 4 bases schucko y T/T más protector de sobretensión.

Enrollables con protector sobretensión.				
005375	3X1	5 mts	12	19,20
005376	3X1	7,5 mts	12	23,50
37307	3X1'5	7,5 mts	10	28,60
005367	3X1	10 mts	12	26,50

- Con 4 bases schucko y T/T más protector de sobretensión.



Enrollables con protector sobretensión.				
37210	3X1'5	10 mts.	10	31,80
37215	3X1'5	15 mts.	10	36,40

- Con 4 bases schucko y T/T más protector de sobretensión.



Para 6 Unid.



Código	Metros	Sección		Precio tarifa	Precio oferta
Enrollables azul cable H05VV-F					
37230	25 mts.	3X1'5	2 / 64	46,60	19,90
37260	50 mts.	3X1'5	2 / 42	79,80	34,90

- Con 4 bases schucko y T/T, protector de sobretensión.



VDE



Enrollables con tapas cable H05VV-F

37252	50 mts.	3X1'5	2 / 42	89,90	41,90
-------	---------	-------	--------	-------	-------

- Con 4 bases schucko y T/T.  
- Protector de sobretensión y tapas.





**Precio  
tarifa**

Código	Metros	Sección	Tambor		Precio tarifa
<b>Enrollacables cable H07RN-F</b>					
3710128	25 mts.	3X1,5	230mm.	1	<b>98,60</b>
3720125	50 mts.	3X1,5	320mm.	1	<b>158,00</b>

- Con 3 bases schucko y T/T, protector de sobretensión y tapas.



**VDE**



**Enrollacables cable H05RN-F (todo goma)**

3710132	25 mts.	3X2,5	285mm.	1	<b>118,00</b>
3720124	40 mts.	3X2,5	320mm.	1	<b>210,00</b>

- Con 4 bases schucko y T/T, protector de sobretensión y tapas.



**VDE**



**Enrollacables garden cable H05VV-F  
con bases y clavija schucko T/T**

3712323	25 mts.	3X1'5	230mm.	1	<b>72,80</b>
---------	---------	-------	--------	---	--------------

- 250V 16A.
- Enrollado máximo 1.000W.
- Desenrollado máximo 3.500 W.



**VDE**





Código	Metros	Sección	Tambor		Precio tarifa
Enrollables cable H05VV-F					
3710188	15 mts.	3X1,5	180mm.	1	47,40

- Con 3 bases schucko y T/T, protector de sobretensión y tapas.



Enrollables Pared cable H05VV-F					
37020	10+1 mts.	3X1,5		2	59,20
37025	15+1 mts.	3X1,5		2	82,80

- Con T/T, protector de sobretensión





Código			Precio tarifa
Tester multifunción comprobador de voltaje 3X1			
89468		25	5,50

- Test de 110V a 380V
- Polaridad.



Tester multifunción comprobador de voltaje 8X1			
89470		25	9,50

- Test de 6V a 380V
- Polaridad.



Buscapolos de 140mm.			
003813		24	1,70



Buscapolos de 190mm.			
003814		24	1,95



Set 2 buscapolos de 110 y 190mm.			
89452		24	2,90







Código	Medida		Precio
<b>Multímetro digital 10 AMP.</b>			

8935255		10	18,60
---------	--	----	-------

- Voltaje DC 200m./2/20/200/600V.
- Voltaje AC 200/600V.
- Corriente DC 2m/20m/200m/10A.
- OHM: 200, -2000K (0.8%+2).
- Curva de frecuencia 50 Hz.
- Batería R9 incluida.
- Aprobado por la CE.
- CAT II.

#### Multímetro digital 10 AMP. C/ temperatura

8935265		10	36,60
---------	--	----	-------

- Voltaje DC: 200m./2/20/200/600V.
- Voltaje AC: 200/600V.
- Corriente DC: 2m/20m/200m/10A.
- OHM: 200, -2000K (0.8%+2).
- Curva de frecuencia 50 Hz.
- Dido 2,8V 1mA.
- Continuidad audible.
- Temperatura: -20° a 750° C.
- Sensor térmico.
- Indicador batería baja.
- Batería R9 incluida.
- Aprobado por la CE.
- CAT II.

#### Multímetro digital compacto

04002387		6	16,80
----------	--	---	-------

- Comprobador de baterías.
- Comprobador de decibelios.
- Batería R03 incluida.
- Aprobado por la CE.

#### Multímetro analógico compacto

8935250		40	14,80
---------	--	----	-------

- 6 Funciones, 14 Rangos.
- Comprobador de baterías.
- Comprobador de decibelios.
- Batería R9 incluida.
- Aprobado por la CE.
- CAT II.

8935275		10	2,40
---------	--	----	------

- CAT II
- 600V.
- Máx. 10A.
- Presentación en bolsa para colgar.



Código	Medida		Precio tarifa
Mini pinza amperimétrica			
8935268		10	18,60

- Función Data Hold.
- Voltaje DC 600V.
- Voltaje AC 600V.
- Corriente AC: 20/200/400A.
- Resistencia: 2K/200K.
- Diodo aprox. 3V.
- Continuidad audible.
- Pantalla LCD.
- Batería R9 incluida aprobado por la CE.
- CAT II.



Pinza amperimétrica con temperatura			
8935270		10	21,40

- Función Data Hold.
- Voltaje DC 200m. /2/20/200/1000V.
- Voltaje AC 200/750V.
- Corriente AC: 20/200/1000A.
- Resistencia: 2K/200K.
- Temperatura: 0° a 750°C.
- Continuidad audible.
- Pantalla LCD.
- Batería R9 incluida aprobado por la CE.
- CAT II.



Pinza amperimétrica automática con temperatura			
8935266		6	38,20

- Función Data Hold.
- Voltaje DC 200m. /2/20/200/600V.
- Voltaje AC /2/20/200/600V.
- Corriente AC: 20/200/600A.
- Resistencia: 2K/200K.
- Temperatura: -20° a 1000°C.
- Diodo: aprox. 1,5V.
- Continuidad audible.
- Pantalla LCD.
- Pantalla con luz.
- Protección sobrecargas.
- Batería R9 incluida aprobado por la CE.
- CAT II.
- Aprobado por CE.

# EXPOSITOR DE SOBREMESA

CÓDIGO: 98046



**EXPOSITOR SIN CARGO  
POR LA COMPRA DE  
300€ NETOS**



**Presentación**

Código	Modelo	Voltaje	Blíster		Precio €
Pilas alcalinas					
38603	LR03	1.5V	4	10	2,40
38606	LR6	1.5V	4	20	2,40
38609	6LR61	9V	1	10	3,90
38612	K23A	12V	1	12	1,65
38614	LR14	1.5V	2	10	4,40
38620	LR20	1.5V	2	10	5,60

- Pilas de altísima calidad y gran rendimiento.
- 1700 mAh.
- Las pilas Kodak Max alcalinas duran hasta un 50% más que cualquier pila de nuestros competidores.
- Pruebas realizadas en nuestros laboratorios Kodak en 2001.
- Son especialmente indicadas para cámaras digitales.
- Las pilas Kodak libres de mercurio en un 99,999%.

## OFERTA

**PARA 6 CAJAS SURTIDAS 45+20%  
PARA 10 CAJAS SURTIDAS 45+30%**

**ECOTASA INCLUIDA**



### Pilas especiales litio

38705	K 123 LA	3V	1	12	7,40
38730	K58L	3V	1	12	6,40

### Pilas especiales litio

38724	KCR2016	3V	1	12	1,80
38725	KCR2025	3V	1	12	1,80
38732	KCR2032	3V	1	12	1,80
38776	LR44	1.5 V	1	12	1,80

**ECOTASA INCLUIDA**



Baterías recargables de NiMH-Akkus  
4 x AAA= R03 800mAh.

Código		P.V.
04002190	10	7,90

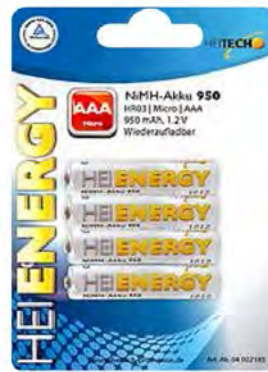

Baterías recargables de NiMH-Akkus  
4 x AAA= R03 950mAh.

Código		P.V.
04002185	10	8,90



Baterías recargables de NiMH-Akkus  
4 x AA= R06 1200mAh.

Código		P.V.
04002182	10	9,40



Baterías recargables de NiMH-Akkus  
4 x AA= R06 2000mAh.

Código		P.V.
04002191	10	15,90



Batería recargable de NiMH-Akkus  
4 x AA= R06 2500mAh.

Código		P.V.
04002183	10	17,60



Batería recargable de NiMH-Akkus  
1 x R09 200mAh.

Código		P.V.
04002186	10	7,60



Cargador de bat. Ni-Cd / Ni-MH con  
2 baterías AAA de 2000 mAh. Y  
2 baterías AA de 800 mAh.

Código		P.V.
09001541	5	24,90



Cargador de bat. Ni-Cd / Ni-MH  
Con descargador y tester

Código		P.V.
09001506	5	14,60



Cargador universal de bat. Ni-Cd/Ni-MH  
Carga R03/R06/R9/R14/R20

Código		P.V.
09001500	5	19,80



Batería Pb.recarcable 6V 4A

Código		P.V.
38045	24	13,80



Batería salina 4R25 - 6V

Código		P.V.
38041	6 / 24	4,20



Batería salina petaca 4,5V  
0% cadmio / mercurio

Código		P.V.
38012	10	2,90



Blister  
5 und.

Batería 12V MN21 = 23A 55mAh

Código		P.V.
3892261	10	4,95



Blister  
5 und.

Batería 12V MN27 = 27A 28mAh

Código		P.V.
3892262	24	4,95

Código		P.V.



**Batería  
9V  
Incluida**

Apto:  
Baterías 1,5V  
Baterías 9V  
Fusibles  
Lámparas

Comprobador baterías 3en1

Código		P.V.
010244	12	15,95



Comprobador de baterías universal

Código		P.V.
04002436	10	5,30



Set 2 Baterías botón  
CR2016 3V **LITIO**

Código		P.V.
04000504	20	1,28



Set 2 Baterías botón  
CR2025 3V **LITIO**

Código		P.V.
04000505	20	1,28



Set 2 Baterías botón  
CR2032 3V **LITIO**

Código		P.V.
04000507	20	1,28



Set 2 baterías botón  
CR2450 3V **LITIO**

Código		P.V.
04000509	20	3,20

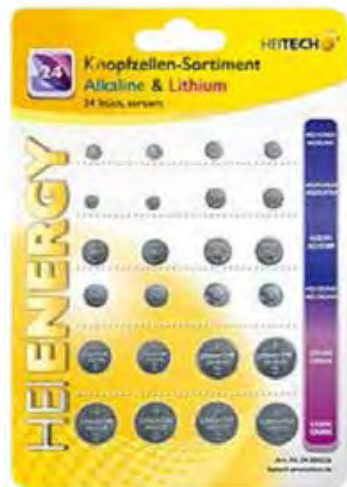

Set 24 baterías surtidas. Alcalina y litio.

Código		P.V.
04000326	20	5,90



Set 12 baterías surtidas. Litio

Código		P.V.
04000384	20	5,90

**2 por tipo**  
 2 - AG1 / LR621  
 2 - AG3 / LR41  
 2 - AG4 / LR626  
 2 - AG5 / LR754  
 2 - AG8 / LR1120  
 2 - AG10 / LR1130

**2 por tipo**  
 2 - AG12 / LR43  
 2 - AG13 / LR44  
 2 - CR1620  
 2 - CR2016  
 2 - CR2025  
 2 - CR2032

**4 por tipo**  
 4 - CR2032  
 4 - CR2025  
 4 - CR2016



Set 4 baterías de botón AG1/LR621

Código		P.V.
04000530	20	1,28

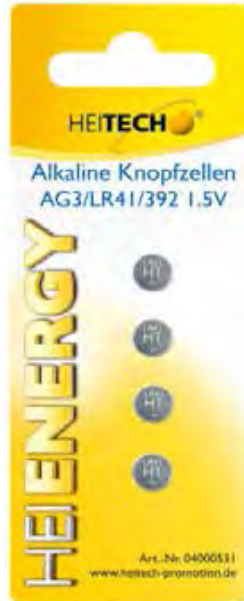

Set 4 baterías de botón AG3/LR41

Código		P.V.
04000531	20	1,28



Set 4 baterías de botón AG4/LR626

Código		P.V.
04000532	20	1,28

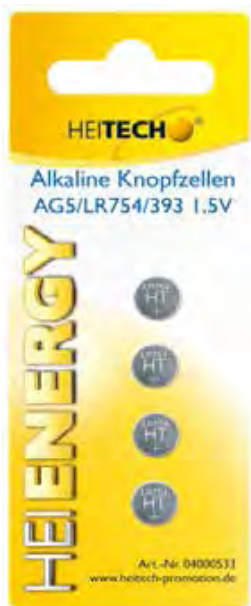

Set 4 baterías de botón AG5/LR754

Código		P.V.
04000533	20	1,28



Set 4 baterías de botón AG10/LR1130

Código		P.V.
04000535	20	1,28

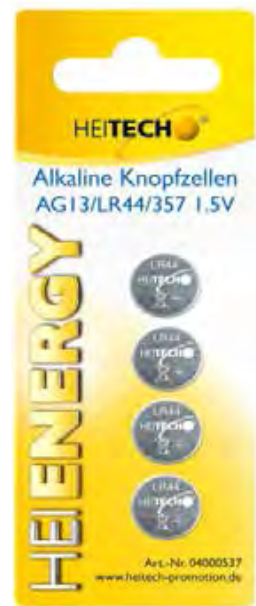

Set 4 baterías de botón AG13/LR44

Código		P.V.
04000537	20	1,28



# PARRILLAS

## mata-insectos

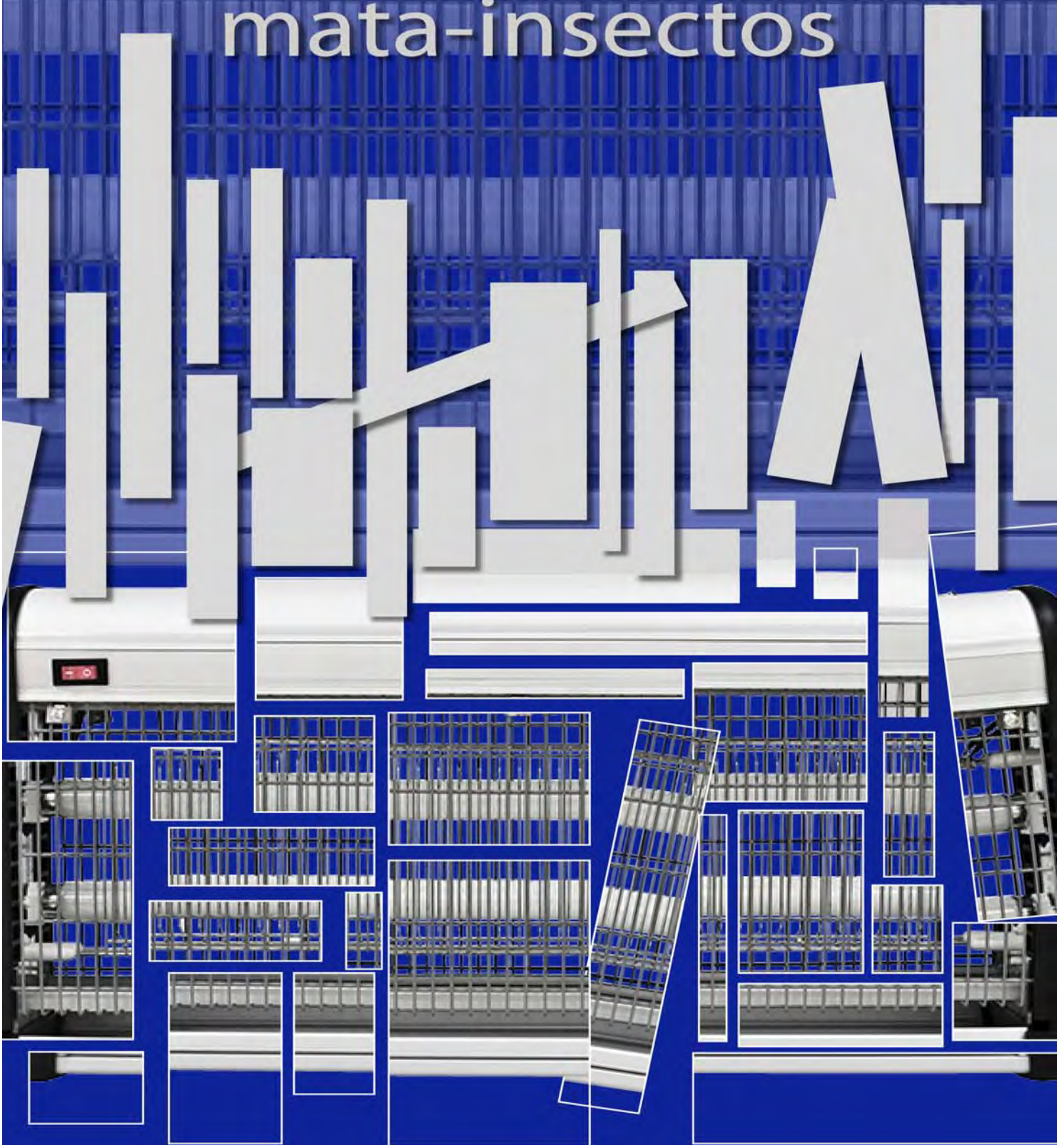



oferta  
3,95€



oferta  
4,95€



oferta  
9,90€



Código	Modelo		Precio €
Ahuyentador de mosquitos			
39201	Blanco	10	8,80

- Conexión a red.
- Con luz niños.



Mini parrilla mata insectos <b>Con luz led</b>			
39202	Blanco	6	11,90

- Conexión a red.
- Con luz niños.



Mini parrilla mata insectos + luz led y ventilador			
39203	Blanco/Azul	12	22,95

- Conexión a red.
- Con luz niños.



**CAJA  
EXPOSITORA  
12 UNIDADES**



oferta  
9,90€

Código	Modelo		Precio €
Parrilla mata insectos plástico con tubo de 6W			
39207	Negro	6	22,60
39208	Blanco	6	22,60

- Medidas: 30X13 cm.



oferta  
19,90€

Parrilla mata insectos LED con ventilador			
39210		6	48,60

- Combina la utilidad de luz noche o lámpara de jardín como de mata insectos.
- Luz led para una máxima atracción.
- El ventilador succiona los insectos hasta la trampa interior para exterminarlos.
- Puede usarse como purificador de aire.



oferta  
25,90€

Parrilla mata mosquitos E27 2X20W			
39209		6	59,95
39209R	Lámpara	10	10,70

- Luz Negra directa a 220V.



Incorpora un sistema de seguridad que al extraer la bandeja de residuos se desconecta automáticamente

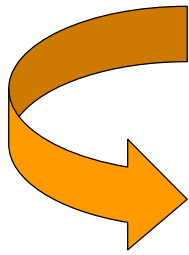

Entrada de mosquitos también por el lateral.



oferta  
22,90€

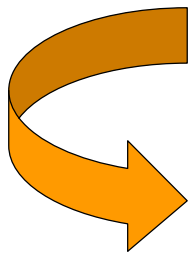

Entrada de mosquitos también por el lateral.



oferta  
28,90€

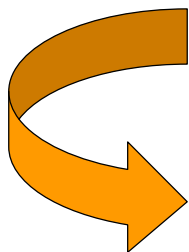

Entrada de mosquitos también por el lateral.

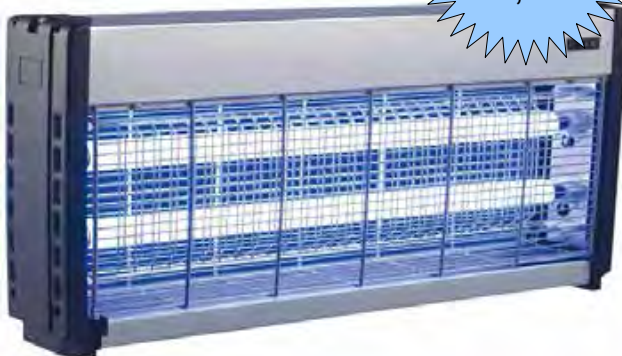

oferta  
31,90€

NOTA DE MEDIDAS: alto, largo, ancho.

Código		Precio
--------	---	--------

Parrilla mata mosquitos 2X8W

39253	6	52,90
-------	---	-------

- Medidas: 26X35X7,5 cm.
- Directo a 220V.



Parrilla mata mosquitos 2X15W

39256	6	63,60
-------	---	-------

- Medidas: 32X50X7,5 cm.



Parrilla mata mosquitos 2X20W

39258	6	74,80
-------	---	-------

- Medidas: 32X50X7,5 cm.





Código	Modelo		Precio €
Ultrasonic 45 m.			
394523		12	20,40

- Señales ultrasónicas potentes y seguras que ahuyentan las plagas de hogares, garajes, desvanes.
- Directo a red 220V.



Ultrasonic 60 m.			
394240		12	26,90

- Señales ultrasónicas potentes y seguras que ahuyentan las plagas de hogares, garajes, desvanes.
- **4 baterías LR14 (no incluidas).**



Ultrasonic 90 m.			
394180		6	29,50

- Señales ultrasónicas potentes y seguras que ahuyentan las plagas de hogares, garajes, desvanes.
- Directo a red 220V.



Ultrasonic por detector de movimiento 200 m2			
394051		2	53,80

- Señales ultrasónicas potentes y seguras que ahuyentan gatos, perros, topos y rapaces
- 4 Baterías R20 (no incluida).

# AHUYENTADORES





Código	Modelo		Precio €
Raqueta mata moscas eléctrica			
39100		12	6,40

**OFERTA**  
**2,99€**

Repelente de insectos y roedores Pest Reject

39310		10	18,40
-------	--	----	-------

- Con luz nocturna ahuyentan las plagas de hogares, garajes, desvanes.
- Directo a 220V

**OFERTA**  
**8,60€**

Repelente de insectos y roedores Pest Reject

39315		10	12,40
-------	--	----	-------

- Con luz nocturna ahuyentan las plagas de hogares, garajes, desvanes.
- Directo a 220V

**OFERTA**  
**5,60€**

Set 4 tiras de atrapamoscas con pegamento

59805	4 tiras	24	1,40
-------	---------	----	------

- Caja expositora con 24 blisters

**OFERTA**  
**069€**

Set 4 tapas de atrapa avispas y voladores

5915427	3 tapas	48	1,40
---------	---------	----	------

**OFERTA**  
**069€**

Código			Precio €
Extractor hogar 12W con rejilla anti-insectos			
50963	Blanco	20	19,80



- Voltaje 220-250V AC.
- Caudal de aire 100 m3/hora
- Velocidad 2250 rpm/min.
- Medidas boca 4" = 10cm.
- Medidas: 158 x 85 x 100 cm.

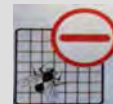

Oferta Caja completa  
**7,90€**

Oferta  
**8,90€**

**Detalle rejilla anti-insectos**

Extractor hogar 15W con rejilla anti-insectos

50964	Blanco	20	21,80
-------	--------	----	-------



- Voltaje 220-250V AC.
- Caudal de aire 150 m3/hora
- Velocidad 1900 rpm/min.
- Medidas boca 5" = 12cm.
- Medidas: 175 x 85 x 120 cm.



Oferta Caja completa  
**8,90€**

Oferta  
**9,90€**

**Detalle rejilla anti-insectos**

Extractor hogar 20W con rejilla anti-insectos

50965	Blanco	20	25,90
-------	--------	----	-------



- Voltaje 220-250V AC.
- Caudal de aire 200 m3/hora
- Velocidad 1800 rpm/min.
- Medidas boca 6" = 15cm.
- Medidas: 205 x 85 x 150 cm.

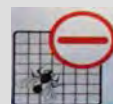

Oferta Caja completa  
**10,90€**

Oferta  
**11,90€**

**Detalle rejilla anti-insectos**

**Código**

**Precio €**
**Extractor semi industrial 35W**

HL960

Blanco

8

**62,80**

- Voltaje 220-250V AC.
- Caudal de aire 450 m3/hora.
- Velocidad 1200 rpm/min.
- Medidas: 24,8X12,5cm.
- Diametro; 16cm

**Oferta  
29,40€**
**Extractor semi industrial 40W**

HL961

Blanco

8

**71,10**

- Voltaje 220-250V AC.
- Caudal de aire 780 m3/hora.
- Velocidad 1500 rpm/min.
- Medidas: 27,5X12,5cm.
- Diametro; 20cm

**Oferta  
33,20€**
**Extractor semi industrial 50W**

HL962

Blanco

8

**85,30**

- Voltaje 220-250V AC.
- Caudal de aire 890 m3/hora.
- Velocidad 1100 rpm/min.
- Medidas: 33,6X13cm.
- Diametro; 25cm

**Oferta  
39,90€**



# LÁMPARAS

incandescentes-halógenas-LED-inducción-fluorescencia



CÓDIGO: 98020  
Medidas: 100 x 205cm.

**OBSEQUIO EXPOSITOR POR LA COMPRA DE 1800€ EN LÁMPARAS**



CÓDIGO: 98170  
Medidas: 170 x 50 x 30cm.

**OBSEQUIO EXPOSITOR POR LA COMPRA DE 600€ EN LÁMPARAS**



CÓDIGO: 98069  
Medidas: 40 x 30 x 13 cm

**OBSEQUIO COMPROBADOR DE LÁMPARAS POR LA COMPRA DE 300€**



Código	Rosca	V	W	Pzs. blís		Precio €
<b>Lámpara estándar clara</b>						
40019	E27	230	25		10/100	<b>0,95</b>
406011	E27	230	40		25/100	<b>0,95</b>
406022	E27	230	60		25/100	<b>0,95</b>
406042	E27	230	100		25/100	<b>1,20</b>
406052	E27	230	200		50	<b>2,80</b>



<b>Lámpara esférica clara</b>						
406111	E14	230	40		25/100	<b>0,95</b>
406122	E14	230	60		25/100	<b>0,95</b>
406162	E27	230	40		25/100	<b>0,95</b>
406172	E27	230	60		25/100	<b>0,95</b>



<b>Lámpara esférica mate</b>						
40032	E14	230	40		10/100	<b>1,28</b>
40033	E14	230	60		10/100	<b>1,28</b>
40036	E27	230	40		10/100	<b>1,28</b>
40037	E27	230	60		10/100	<b>1,28</b>



<b>Lámpara esférica 12V</b>						
40522	E27	<b>12V</b>	40		10	<b>2,10</b>



<b>Lámpara vela clara</b>						
406212	E14	230	40		25/100	<b>0,95</b>
406222	E14	230	60		25/100	<b>0,95</b>



<b>Lámpara vela flíquer o llama</b>						
40012	E14	230	5		25/100	<b>1,90</b>

**Medidas:** 90x30 mm

# ESPECIALIDADES



Código	Rosca	V	W		Precio €
Lámpara Luz mezcla directa a 220-230V					
HL401	2000Lm	220-230	125	10	<b>2,50</b>
HL402	2500Lm	220-230	160	10	<b>2,50</b>

- E27
- 8.000 horas de vida.
- Medidas: 155X70mm.



Lámpara tubular 20X50

40205	E14	220	7	25/100	<b>0,96</b>
40210	E14	220	10	25/100	<b>0,96</b>
40215	E14	220	15	25/100	<b>0,96</b>



Lámpara pebetero

40308	E14	220	15	25/100	<b>0,96</b>
40312	E14	220	25	25/100	<b>0,96</b>



Lámpara tubular horno 300°

40218	E14	220	15	50	<b>1,90</b>
-------	-----	-----	----	----	-------------



Lámpara T25L cocina campanas

40220	E14	230	40	25/100	<b>1,70</b>
-------	-----	-----	----	--------	-------------

- 80x26



Código	Rosca	V	W			Precio €
Lámpara reflectora R-63						
41816	E27	230	40		25/100	<b>2,10</b>
41817	E27	230	60		25/100	<b>2,10</b>



#### Lámpara reflectora R-125 INFRAROJOS

41850	E27	230	150		5 / 50	<b>11,50</b>
-------	-----	-----	-----	--	--------	--------------

- Voltaje 230-240V.
- Especial para calefacción y fisioterapeutas.



#### Lámpara reflectora R-125 INFRAROJOS

41856	E27	230	250		5 / 50	<b>11,50</b>
-------	-----	-----	-----	--	--------	--------------

- Voltaje 230-240V.
- Especial para calefacción y fisioterapeutas.





# NUEVAS LÁMPARAS halógenas ecológicas

220-240V



Código	Rosca	Luz	W	Equiv.	Lumens		Precio €	Precio € Neto
Lámpara estándar classic halógena <b>ECOLÓGICA</b>								
41701	E27	2800	18	25	160	10/100	<b>1,70</b>	<b>0,69</b>
41703	E27	2800	42	60	510	10/100	<b>1,70</b>	<b>0,69</b>
41704	E27	2800	52	75	820	10/100	<b>1,70</b>	<b>0,69</b>
41705	E27	2800	70	100	1180	10/100	<b>1,90</b>	<b>0,79</b>
77655	E27	2800	105	150	1995	10/50	<b>3,50</b>	<b>1,69</b>



Lámpara esférica clara halógena <b>ECOLÓGICA</b>								
41716	E27	2800	28	40	295	10/100	<b>1,70</b>	<b>0,69</b>
41717	E27	2800	42	60	510	10/100	<b>1,70</b>	<b>0,69</b>



Lámpara Esférica halógena <b>ECOLÓGICA</b>								
41711	E14	2800	28	40	295	10/100	<b>1,70</b>	<b>0,69</b>
41712	E14	2800	42	60	510	10/100	<b>1,70</b>	<b>0,69</b>



Mate

Lámpara vela clara halógena <b>ECOLÓGICA</b>								
41721	E14	2800	28	40	295	10/100	<b>1,70</b>	<b>0,69</b>
41722	E14	2800	42	60	510	10/100	<b>1,70</b>	<b>0,69</b>

Lámpara vela mate halógena <b>ECOLÓGICA</b>								
77732	E14	2800	42	60	510	10/100	<b>1,90</b>	<b>0,79</b>





Código	casquillo	voltios	watios		Precio €	Precio Neto
Lámpara <b>ECOLÓGICA</b> microica 50mm. 12V						
41362	G5.3	cerrad.	35=50	10/100	1,50	0,69
41366	G5.3	cerrad.	35=50	10/100	1,90	0,69

**Códigos rojos son en blister con 1 unidad.**

**Las lámparas halógenas ecológicas son las sustitutas**



Lámpara **ECOLÓGICA** lineales 220 / 230V

41411	R7s	78	80=100	10	2,10	0,99
41412	R7s	78	120=150	10	1,92	0,89
41413	R7s	78	150=200	10	1,92	0,89
41420	R7s	117	80=100	10	2,10	0,99
41421	R7s	117	150=200	10	1,92	0,89
41422	R7s	117	240=300	10	1,92	0,89
41427	R7s	117	240=300	10	4,24	1,99

**Códigos rojos son en blister con 2 unidades.**



Lámpara **ECOLÓGICA** bi-pin halógenas

41430	G4	12V	7=10	10	0,84	0,39
41433	G6.35	12V	35=50	10	1,20	0,55



Código	casquillo	varios	watios		Precio €	Oferta neto
<b>Lámpara mini dicroica 35mm. 12V</b>						
41319	G-4	cerrada	20	10/200	1,46	0,55
<b>Lámpara dicroica halógena 50 mm. 12V</b>						
41341	G-5'3-38°	cerrada	35	10/200	1,26	0,55
41356	G-5'3-60°	cerrada	50	10/200	1,26	0,55
41357	G-5'3-38°	cerrada	50	10/200	1,26	0,55
<b>Lámpara dicroica halógena 50 mm. 220/230V</b>					<b>PHILIPS</b>	
4165434	GU10 - 40°	cerrada	50	24	2,25	1,15
<b>Lámpara dicroica halógena 50 mm. 220/230V</b>					<b>para 10 unidades</b>	
41474	GU10 - 38°	cerrada	50	10/200	2,10	0,95
					<b>para 50 unidades</b>	
					<b>0,75</b>	
<b>Lámparas lineales halógenas 220 / 230V</b>						
41404	R7s	78	100	20/500	1,65	0,69
41401	R7s	78	150	20/500	1,65	0,69
41407	R7s	78	200	20/500	1,65	0,69
41392	R7s	117	100	10/500	1,65	0,69
41396	R7s	117	300	10/500	1,65	0,69
41403	R7s	117	500	10/500	1,65	0,69
41398	R7s	185	1000	10/200	4,40	1,95
41399	R7s	250	1500	10/200	4,90	2,15
<b>Lámpara bi-pin halógenas</b>						
41387	GY6'35	12	50	10	1,20	0,39
<b>Lámpara bi-pin halógenas ( Blue ) Luz blanca</b>						
41370	G4	12	20	10	1,20	0,39
<b>Lámpara G9 halógenas Clara</b>						
41378	G9	220-240	40	20	1,80	0,60
<b>Lámpara G9 halógenas Mate</b>						
41379	G9	220-240	40	20	1,80	0,60
<b>Lámpara G9 halógenas ( Blue ) Luz blanca</b>						
41390	G9	220-240	40	10	1,80	0,60

**Códigos rojos son en blister con 1 unidad.**

## HALÓGENAS

## AR111



Precio €  
tarifa

Precio €  
oferta

Código	casquillo	voltios	watios		Precio € tarifa	Precio € oferta
Lámpara halógena 24° AR 111						
41325	G53	12	50	50	2,90	1,29
41326	G53	12	75	50	2,90	1,29

- Bajo voltaje. **12 V.**
- Se utiliza con transformador.
- Lámpara de cuarzo.
- Rayos U.V. Stop.

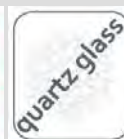

## SYLVANIA

## PAR56

Lámpara Par 56 Piscinas, Fuentes

9061532	G-53	12V	300	12	28,50	13,90
---------	------	-----	-----	----	-------	-------

- Bajo voltaje, por normativa obligatorio.
- Cristal resistente al calor.
- Se utiliza con transformador.

**12 V.**

## HALÓGENAS

## PAR38

Lámpara PAR 38 Halógena

41330	E27	230	80	20	6,80	3,19
-------	-----	-----	----	----	------	------

- Luz Halógena sin transformador.
- Reflector aluminizado.
- Se puede regular con reguladores estándar.

## HALÓGENAS COLORES

## PAR38

Lámpara PAR 38 Halógena colores

41331	E27	230	80	20	6,80	3,19
41332	E27	230	80	20	6,80	3,19
41333	E27	230	80	20	6,80	3,19







SMD  
LED

TECNOLOGIA LED

# ABS

## LÁMPARAS ESTÁNDAR



**POR LA COMPRA DE 20 CAJAS SURTIDAS DE ESTA PÁGINA  
OBSEQUIO UNA CAJA DE CADA DE LÁMPARAS ESTÁNDAR LED 10W  
CÓDIGOS: 41778-41779**

**BLISTER**

Modelo	W	Rosca	Luz	Lumen		Precio € Tarifa	Precio € Oferta
Lámpara opal MS-A60 tipo estándar de Led 175-240V 50-60Hz. Apertura 160° MD-A60							
41686	<b>10W</b>	E27	3000K	850	10	7,40	2,75
41687		E27	6000K	850	10	7,40	2,75
41661	<b>6W</b>	E27	3000K	480	12	4,40	1,79
41662		E27	6000K	480	12	4,40	1,79
41665	<b>10W</b>	E27	3000K	850	12	7,40	2,60
41740		E27	4000K	850	12	7,40	2,60
41666		E27	6000K	850	12	7,40	2,60
41667	<b>12W</b>	E27	3000K	1050	12	8,90	2,80
41741		E27	4000K	1050	12	8,90	2,80
41668		E27	6000K	1050	12	8,90	2,80
41669	<b>15W</b>	E27	3000K	1230	10	14,90	3,75
41770	<b>16W</b>	E27	3000K	1760	12	14,90	5,85
41771		E27	6000K	1760	12	14,90	5,85
41772	<b>20W</b>	E27	3000K	2180	12	19,50	8,65
41773		E27	6000K	2180	12	19,50	8,65

**4,5W**
**BLISTER**

Código	Rosca	Luz	Lumen		Precio € Tarifa	Precio € Oferta
Lámpara opal tipo esférica de Led - 220-240V 50-60Hz. 4,5W.						
41680	E27	3000K	330	10	<b>6,70</b>	<b>1,69</b>
41682	E14	3000K	330	10	<b>6,70</b>	<b>1,69</b>

**5W**

Lámpara opal tipo esférica de Led - 220-240V 50-60Hz. 5W.

41601	E27	3000K	360	10	<b>6,70</b>	<b>1,79</b>
41602	E27	6000K	360	12	<b>6,70</b>	<b>1,79</b>
41603	E14	3000K	360	12	<b>6,70</b>	<b>1,79</b>
41604	E14	6000K	360	12	<b>6,70</b>	<b>1,79</b>

**7W**

Lámpara opal tipo esférica de Led - 220-240V 50-60Hz. 7W.

41671	E27	3000K	550	12	<b>7,90</b>	<b>2,39</b>
41744	E27	4000K	550	12	<b>7,90</b>	<b>2,39</b>
41672	E27	6000K	550	12	<b>7,90</b>	<b>2,39</b>
41673	E14	3000K	550	12	<b>7,90</b>	<b>2,39</b>
41745	E14	4000K	550	12	<b>7,90</b>	<b>2,39</b>
41674	E14	6000K	550	12	<b>7,90</b>	<b>2,39</b>

- Medidas: 75mm. X 45mm.
- Ángulo de apertura: 140°.

**4,5W**
**BLISTER**

Lámpara opal tipo vela de Led - 220-240V 50-60Hz. 4,5W.

41684	E14	3000K	330	10	<b>6,70</b>	<b>1,69</b>
-------	-----	-------	-----	----	-------------	-------------

**5W**

Lámpara opal tipo vela de Led - 220-240V 50-60Hz. 5W.

41605	E14	3000K	360	12	<b>6,70</b>	<b>1,79</b>
41606	E14	6000K	360	12	<b>6,70</b>	<b>1,79</b>

**7W**

Lámpara opal tipo vela de Led - 220-240V 50-60Hz. 7W.

41675	E14	3000K	550	10	<b>7,90</b>	<b>2,39</b>
41746	E14	4000K	550	12	<b>7,90</b>	<b>2,39</b>
41676	E14	6000K	550	12	<b>7,90</b>	<b>2,39</b>

**7W**

Lámpara opal tipo vela punta de Led - 220-240V 50-60Hz. 7W.

41677	E14	3000K	550	10	<b>7,90</b>	<b>2,39</b>
-------	-----	-------	-----	----	-------------	-------------

# ABS

## ESPECIALIDADES



Modelo	W	Rosca	Luz	Lumen		Precio € Tarifa	Precio € Oferta
--------	---	-------	-----	-------	---	--------------------	--------------------

Lámpara opal tipo estándar y esférica de Led, 50-60Hz. Apertura 160°

<b>12V</b>	41840	<b>7W</b>	E27	4000K	560	12	7,90	3,40
	41845	<b>5W</b>	E27	4000K	360	12	6,50	2,90
<b>12/24V</b>	41846	<b>5W</b>	E27	4000K	360	12	8,60	3,90



Lámpara dicroica MR16 12V, 50-60Hz. Apertura 120°

<b>12V</b>	41847	<b>8W</b>	E27	3000K	640	12	10,80	3,75
	41848	<b>8W</b>	E27	6000K	640	12	10,80	3,75

Lámpara opal tipo estándar con sensor, 50-60Hz. Apertura 160°

<b>CON SENSOR CREPUSCULAR</b>	41292	<b>10W</b>	E27	4000K	810	12	16,90	7,60
---------------------------------------	-------	------------	-----	-------	-----	----	-------	------

Lámpara opal tipo estándar, 50-60Hz. Apertura 360°

<b>ESPECIAL 360°</b>	41774	<b>10W</b>	E27	3000K	1000	12	9,90	4,50
	41775		E27	6000K	1000	12	9,90	4,50

**FUNCIONA COMO UNA LÁMPARA TRADICIONAL Y COMO UNA DE EMERGENCIA**



**OFERTA  
9,90€**

Lámpara Led SMD emergencia cuerpo ABS, 220-240V 50-60Hz.

41293	7W	E27	3000K	400	12	21,90	9,90
41294	7W	E27	6000K	400	12	21,90	9,90



**OFERTA  
22,90€**

**SE CONTROLA  
CON UNA APP  
DESDE EL MÓVIL**

- Totalmente dimable.
- Todo tipo de tonos de luz (16 millones de colores).
- Programable/ auto-encendido.
- 8 modos pre-programados.
- Velocidad ajustable.
- Control por voz y movimiento.
- Posibilidad de sincronizar con varias unidades a la vez.
- Muy fácil de manejar.



Lámpara Led SMD "FIESTA", 220-240V 50-60Hz.

41600	8W	E27			6	54,80	22,90
-------	----	-----	--	--	---	-------	-------

# LÁMPARAS LED FILAMENTO



Precio € Precio €

Código	Medidas	Rosca	Luz	Lumen	watios		Tarifa	Oferta
--------	---------	-------	-----	-------	--------	--	--------	--------

Lámpara tipo ST64 VINTAGE de Led

41787		115X55	E27	2700K	810	<b>6W</b>	6/12	19,60	8,50
-------	---	--------	-----	-------	-----	-----------	------	-------	------

Lámpara tipo filamento A60 de Led

41533		106X60	E27	6400K	400	<b>5W</b>	12	6,40	2,90
41780		106X60	E27	2700K	600	<b>6W</b>	12	7,20	3,75
41781		106X60	E27	2700K	1020	<b>8W</b>	12	9,80	4,90

Lámpara tipo filamento A45 esférica de Led

41783		78,5X45	E27	2700K	320	<b>4W</b>	10	5,60	2,60
41537		78,5X45	E14	6400K	240	<b>3W</b>	10	5,30	2,45

Lámpara tipo filament Vela de Led

41785		100X35	E14	2700K	320	<b>4W</b>	12	5,60	2,60
-------	---	--------	-----	-------	-----	-----------	----	------	------

# ABS



Modelo		Rosca	Luz	Lumen		Precio € Tarifa	Precio € Oferta
Lámpara SERIE R50 de Led, 220-240V 50-60Hz.							
41693	<b>8W</b>	E14	3000K	600	12	6,20	2,70
41694		E14	6000K	600	12	6,20	2,70
Lámpara SERIE R63 de Led, 220-240V 50-60Hz.							
41695	<b>10W</b>	E27	3000K	750	12	7,60	3,40
41696		E27	6000K	750	12	7,60	3,40
Lámpara SERIE R80 de Led, 220-240V 50-60Hz.							
41697	<b>13W</b>	E27	3000K	975	12	10,40	4,70
41698		E27	6000K	975	12	10,40	4,70



Lámpara SERIE AR111 MARCA HEPOLUZ

<b>12V</b>	41798	<b>15W</b>	G53	3000K	1380	12	21,90	9,90
<b>220V</b>	41799		GU10	3000K	1380	12	21,90	9,90

Lámpara SERIE AR111 MARCA I-LIGHT

	67535	<b>12W</b>	G53	3000K	1100	50	21,90	9,90
	67536		G53	4200K	1100	50	21,90	9,90
<b>12V</b>	67537		G53	6400K	1100	50	21,90	9,90
	67541		GU10	4200K	1100	50	21,90	9,90
<b>220V</b>	67542		GU10	6400K	1100	50	21,90	9,90



**6W**



**9W**



**5W**



**8W**



**10W**

Código	Rosca	Lum.	Luz		Precio €	Oferta neto
Lámpara 220-240V. led <b>6W</b> tipo - 50mm.						
41541	GU10	480	3000K	10	<b>8,90</b>	<b>2,49</b>

- 14 SMD 50X35.
- Apertura 120°.

Lámpara 220-240V. led <b>9W</b> tipo - 50mm.						
41566	GU10	750	2700K	10	<b>21,80</b>	<b>4,90</b>

- 16 SMD 50X50.
- Apertura 120°.

Lámpara 220-240V. led <b>5W</b> tipo - 50mm.						
41688	GU10	450	3000K	10	<b>7,90</b>	<b>2,49</b>
41689	GU10	450	6000K	10	<b>7,90</b>	<b>2,49</b>

Lámpara 220-240V. led <b>5W</b> tipo - 50mm.						
41543	GU10	450	3000K	12	<b>7,90</b>	<b>2,49</b>
41544	GU10	450	6000K	12	<b>7,90</b>	<b>2,49</b>

- 40 SMD 35X35.
- Apertura 120°.

Lámpara 220-240V. led <b>8W</b> tipo - 50mm.						
41862	GU10	640	3000K	12	<b>10,80</b>	<b>3,75</b>
41863	GU10	640	6000K	12	<b>10,80</b>	<b>3,75</b>

- Diámetro: 50mm.
- Apertura: 120°

**COB LED**

Lámpara 220-240V. SMD led <b>10W</b> tipo - 50mm.						
41864	GU10	765	3000K	12	<b>12,50</b>	<b>4,50</b>
41865	GU10	765	6000K	12	<b>12,50</b>	<b>4,50</b>

- Cuerpo de ceramica
- Diámetro: 50mm.
- Apertura: 120°

**10W**



# Lámparas LED G4 y G9



**3,5W**

Lámpara G4 GEL SMD Led 3,5W 12V - 50Hz.

41897	G4	3000K	210	12	<b>5,95</b>	<b>2,49</b>
41898	G4	6000K	210	12	<b>5,95</b>	<b>2,49</b>

- Medidas: 37X12mm.



**3W**

Lámpara G4 GEL **COB** Led 3W 12V - 50Hz.

41899	G4	3000K	230	12	<b>8,90</b>	<b>3,75</b>
41900	G4	6000K	230	12	<b>8,90</b>	<b>3,75</b>

- Medidas: 30X9mm.



**3,5W**

Lámpara G9 GEL Led 3,5W 220-240V - 50Hz.

41869	G9	3000K	210	10	<b>8,90</b>	<b>2,49</b>
-------	----	-------	-----	----	-------------	-------------

- Medidas: 50X14mm.



**5W**

Lámpara G9 Led 5W 220-240V - 50Hz.

41870	G9	3000K	350	10	<b>8,90</b>	<b>2,99</b>
41871	G9	6000K	350	10	<b>8,90</b>	<b>2,99</b>

- Medidas: 50X14mm.



**3,8W**

Lámpara G9 Led 3,8W 220-240V - 50Hz.

41568	G9	2700K	300	10	<b>8,90</b>	<b>1,95</b>
41569	G9	6500K	300	10	<b>8,90</b>	<b>1,95</b>

# ABS

## ESPECIALIDADES



Lámpara lineal led J78mm R7S Diam. 23mm, 220-240V 50-60Hz.

67519	<b>5W</b>	R7S	3000K	480	10	<b>15,20</b>	<b>6,70</b>
67520		R7S	6400K	500	10	<b>15,20</b>	<b>6,70</b>

Lámpara lineal led J118mm R7S Diam. 23mm, 220-240V 50-60Hz.

41762	<b>9W</b>	R7S	3000K	900	12	<b>15,90</b>	<b>6,70</b>
-------	-----------	-----	-------	-----	----	--------------	-------------

- Apertura 360°      Diámetro: 23mm.



### ULTRA SLIM

**15mm DIÁMETRO**



Lámpara lineal led ULTRA SLIM J118mm R7S Diam. 15mm, 220-240V 50-60Hz.

41765	<b>10W</b>	R7S	6000K	900	12	<b>21,90</b>	<b>9,95</b>
-------	------------	-----	-------	-----	----	--------------	-------------

- Apertura 360°      Diámetro: 15mm.



15W



2W



4W

Código	Rosca	Lum.	Luz		Precio €	Oferta neto
Lámpara GLOBO						
41790	E27	1245	3000K	12	12,20	5,50
41791	E27	1245	6000K	12	12,20	5,50

- Medidas: Altura 156mm, Diámetro: 120mm



Lámpara Pebetero 2W

41796	E14	160	3000K	12	4,85	2,20
-------	-----	-----	-------	----	------	------

- Medidas: Altura 60mm, Diámetro: 26mm



Lámpara T25 filamento led 4W

41797	E14	400	3000K	12	5,80	2,60
-------	-----	-----	-------	----	------	------



- Especial campana extractora

- Medidas: Altura 84mm, Diámetro: 25mm







precio OFERTA solo para cajas completas

Código	Medidas	Rosca	Luz	Lumen	watios		Precio € Tarifa	Precio € Oferta	
Lámpara LED PAR38 E27 Metal 220-240V 50-60Hz.									
41338			E27	6000K	960	<b>12W</b>	10	24,90	8,80

Lámpara LED PAR38 E27 ABS 220-240V 50-60Hz.

41339			E27	3000K	1600	<b>18W</b>	10	24,90	9,90
41340			E27	VERDE	1600	<b>18W</b>	10	24,90	9,90

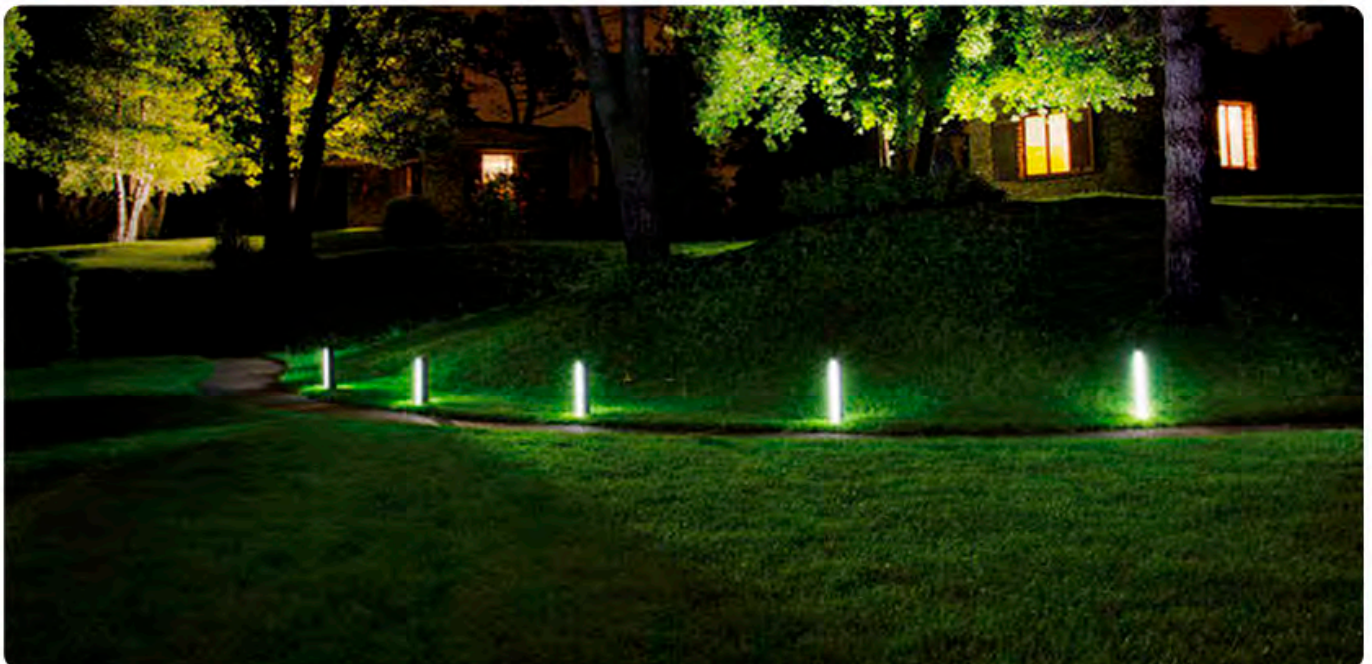

# ABS



**Precio oferta SOLO para cajas completas**

Código	Medidas	Rosca	Luz	Lumen	watios		Precio € Tarifa	Precio € Oferta
Lámpara alto vataje en LED								
41061	175X60	E27	6000K	1960	<b>22W</b>	10	16,20	5,90
41063	225X75	E27	6000K	2250	<b>26W</b>	10	20,60	6,90
41065	245X72	E27	6000K	2940	<b>32W</b>	10	27,20	8,90
41067	275X80	E27	6000K	3530	<b>38W</b>	10	31,60	9,90
41069	280X80	E40	6000K	3530	<b>38W</b>	10	31,60	9,90

- Tipo de LED SMD.
- Compatibilidad electromagnética WEEE Aprobado.
- EMC Aprobado.



# LAMPARAS SEMI INDUSTRIALES



**Precio oferta SOLO para cajas completas**

Código	Medidas	Rosca	Luz	Lumen	watios		Precio € Tarifa	Precio € Oferta
Lámpara alto vatage en LED								
41071	151X81	E27	6000K	1690	<b>20W</b>	10	16,90	7,90
41073	185X100	E27	6000K	2540	<b>30W</b>	10	21,80	9,90
41075	214X118	E27	6000K	3250	<b>40W</b>	10	26,80	12,50

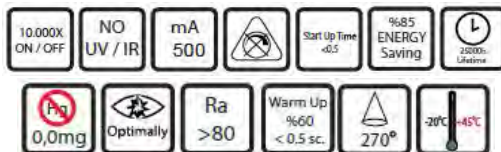

# Tubos LED



Código	Rosca	Luz	W	Lumen		Precio € Tarifa	Precio € Oferta
Tubos T8 de Led							
41755	G13	4000K	9W	800	20	13,60	3,60
41756	G13	6000K	9W	850	20	13,60	3,60
41757	G13	4000K	18W	1700	20	17,60	4,60
41758	G13	6000K	18W	1750	20	17,60	4,60
41759	G13	6000K	23W	2150	20	23,90	7,50

**Fijo**

Medidas: 600X26 mm.  
1200X26 mm.  
1500X26 mm.



**EXCELENTE  
ACABADO**

**SMD  
LED**

**Para sustituir tubos fluorescentes con balastro magnético**

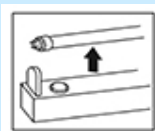

**Paso 1º**  
Cortar la corriente principal y quitar el tubo fluorescente.

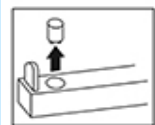

**Paso 2º**  
Quitar el cebador. **Este tubo no necesita ningún cebador ni puenteado.**

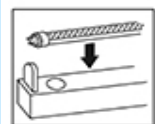

**Paso 3º**  
Coloque el tubo de LED.

**Importante:**

En este caso la luminaria será conforme al estándar de la CE.

**Para sustituir tubos fluorescentes con balastro electrónico**

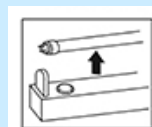

**Paso 1º**  
Cortar la corriente principal y quitar el tubo fluorescente.

**Paso 2º**

Anular el balastro y conectar la FASE a un lado de la regleta y el NEUTRO al otro lado.



# Tubos de cristal LED



**TIRA LED COLOCADA EN GUIA NO PEGADA**

Código	Rosca	Luz	W	Lumen		Precio € Tarifa	Precio € Oferta
Tubos T8 de Led							
41752	G13	6000K	9W	800	20	10,90	3,60
41754	G13	6000K	18W	1650	20	12,90	4,50
41750	G13	6000K	23W	2100	20	16,50	7,50

**Fijo**

Medidas: 600X26 mm.  
1200X26 mm.



**Para sustituir tubos fluorescentes con balastro magnético**

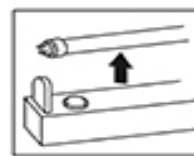

**Paso 1º**

Cortar la corriente principal y quitar el tubo fluorescente.

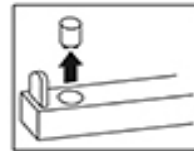

**Paso 2º**

Quitar el cebador. **Este tubo no necesita ningún cebador ni puenteado.**

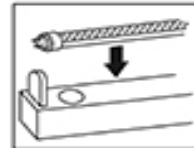

**Paso 3º**

Coloque el tubo de LED.

**Importante:**

En este caso la luminaria será conforme al

**Para sustituir tubos fluorescentes con balastro electrónico**

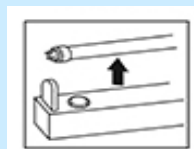

**Paso 1º**

Cortar la corriente principal y quitar el tubo fluorescente.

**Paso 2º**

Anular el balastro y conectar la FASE a un lado de la regleta y el NEUTRO al otro lado.







ABS



Modelo		Rosca	Luz	Lumen		Precio € Neto	Precio € Oferta
Lámpara opal MS-A60 tipo estándar de Led						175-240V 50-60Hz.	Apertura 160°
31001	<b>5W</b>	E27	3000K	500	10	3,90	1,80
31002		E27	4200K	500	10	3,90	1,80
31003		E27	6400K	500	10	3,90	1,80
31004	<b>6W</b>	E27	3000K	600	10	4,40	1,90
31005		E27	4200K	600	10	4,40	1,90
31006		E27	6400K	600	10	4,40	1,90
31007	<b>8W</b>	E27	3000K	850	10	5,30	2,45
31008		E27	4200K	850	10	5,30	2,45
31009		E27	6400K	850	10	5,30	2,45
31010	<b>10W</b>	E27	3000K	1000	10	6,50	2,75
31011		E27	4200K	1000	10	6,50	2,75
31012		E27	6400K	1000	10	6,50	2,75
31013	<b>12W</b>	E27	3000K	1050	10	7,90	2,95
31014		E27	4200K	1050	10	7,90	2,95
31015		E27	6400K	1050	10	7,90	2,95
31016	<b>15W</b>	E27	3000K	1400	10	8,70	3,75
31017		E27	4200K	1400	10	8,70	3,75
31018		E27	6400K	1400	10	8,70	3,75
31022	<b>10W</b>	E27	3000K	900	10	7,50	3,50
31023		E27	4200K	900	10	7,50	3,50
21024		E27	6400K	900	10	7,50	3,50
31019	<b>8W</b>	E27	3000K	600	10	9,20	4,20
31020		E27	4200K	600	10	9,20	4,20
31021		E27	6400K	600	10	9,20	4,20

ESPECIAL  
DIMABLE





ESPECIAL  
360°

- Medidas de la lámpara 110X60 mm. - Tipo de LED SMD.  
- Compatibilidad electromagnética WEEE Aprobado.- EMC Aprobado.

mínimo de 300 lámparas surtidas de las 4 hojas y siempre cajas completas

# ABS



Código	Medidas	Rosca	Luz	Lumen	watios		Precio € Tarifa	Precio € Oferta	
Lámpara opal tipo Vela de Led 110-240V 50-60Hz. Tipo de LED SMD									
31040		98X37	E14	3000K	250	<b>3,5W</b>	10	3,95	1,75
31042		98X37	E14	6400K	250		10	3,95	1,75
31043		131X37	E14	3000K	480	<b>6W</b>	10	4,90	2,20
31044		131X37	E14	4200K	480		10	4,90	2,20
31045		131X37	E14	6400K	480		10	4,90	2,20
Lámpara opal tipo Vela punta de Led									
31046		131X37	E14	3000K	250	<b>3,5W</b>	10	3,95	1,75
31048		131X37	E14	6400K	250		10	3,95	1,75
31049		131X37	E14	3000K	480	<b>6W</b>	10	4,90	2,20
31050		131X37	E14	4200K	480		10	4,90	2,20
31051		131X37	E14	6400K	480		10	4,90	2,20
Lámpara opal tipo esférica de Led									
31052		73,3X45	E27	3000K	250	<b>3,5W</b>	10	3,95	1,75
31054		73,3X45	E27	6400K	250		10	3,95	1,75
31058		73,3X45	E27	3000K	480	<b>6W</b>	10	4,90	2,20
31059		73,3X45	E27	4200K	480		10	4,90	2,20
31060		73,3X45	E27	6400K	480		10	4,90	2,20
Lámpara opal tipo esférica de Led									
31055		73,3X45	E14	3000K	250	<b>3,5W</b>	10	3,95	1,75
31057		73,3X45	E14	6400K	250		10	3,95	1,75
31061		73,3X45	E14	3000K	480	<b>6W</b>	10	4,90	2,20
31062		73,3X45	E14	4200K	480		10	4,90	2,20
31063		73,3X45	E14	6400K	480		10	4,90	2,20

- Tipo de LED SMD.
- Compatibilidad electromagnética WEEE Aprobado.
- EMC Aprobado.



# Lámparas LED filamento



Código	Medidas	Rosca	Luz	Lumen	watios		Precio € Tarifa	Precio € Oferta
--------	---------	-------	-----	-------	--------	---	--------------------	--------------------

Lámpara opal tipo A60 de Led

31069		106X60	E27	3000K	320	<b>4W</b>	10	5,50	2,79
31070		106X60	E27	4200K	320		10	5,50	2,79
31071		106X60	E27	3000K	400	<b>6W</b>	10	6,80	3,69
31072		106X60	E27	4200K	400		10	6,80	3,69
31073		106X60	E27	3000K	500	<b>8W</b>	10	8,80	4,99
31074		106X60	E27	4200K	500		10	8,80	4,99

Lámpara opal tipo Vela de Led

31065		98X35	E14	3000K	320	<b>4W</b>	10	5,60	2,45
31066		98X35	E14	4200K	320		10	5,60	2,45

Lámpara opal tipo Vela punta de Led

31067		118X35	E14	3000K	320	<b>4W</b>	10	5,60	2,45
31068		118X35	E14	4200K	320		10	5,60	2,45

# ABS



Precio €  
Tarifa

Precio €  
Oferta

Código	Modelo	Medidas	Rosca	Luz	Lumen	watios		Precio € Tarifa	Precio € Oferta
--------	--------	---------	-------	-----	-------	--------	---	--------------------	--------------------

Lámpara GU10 Led  
175-240V 50-60Hz.

Tipo de LED SMD

31100		55X50	GU10	3000K	250	<b>4W</b>	10	3,90	1,85
31101		55X50	GU10	4200K	250		10	3,90	1,85
31102		55X50	GU10	6400K	250		10	3,90	1,85
31103		55X50	GU10	3000K	390	<b>6W</b>	10	5,40	2,60
31104		55X50	GU10	4200K	390		10	5,40	2,60
31105		55X50	GU10	6400K	390		10	5,40	2,60
31106		55X50	GU10	3000K	630	<b>8W</b>	10	8,40	3,90
31107		55X50	GU10	4200K	630		10	8,40	3,90
31108	55X50	GU10	6400K	630	10		8,40	3,90	

Lámpara GU10 Led  
175-240V 50-60Hz.

Tipo de LED SMD

31110	<b>ESPECIAL DIMABLE</b>	55X50	GU10	3000K	390	<b>6W</b>	10	7,90	3,70
31111		55X50	GU10	4200K	390		10	7,90	3,70
31112		55X50	GU10	6400K	390		10	7,90	3,70

Lámpara Bi pin 12V DC Led

41893		34X12	G4	3000K	110	<b>1,5W</b>	25	2,90	1,40
41894		34X12	G4	6400K	110		25	2,90	1,40

Lámpara G9 Led  
220-240V 50-60Hz.

41889		54X16	G9	3000K	180	<b>3W</b>	25	4,90	2,30
41890		54X16	G9	6400K	180		25	4,90	2,30
41891		54X16	G9	3000K	230	<b>5W</b>	25	5,90	2,75
41892		54X16	G9	6400K	230		25	5,90	2,75

- Tipo de LED SMD.
- Compatibilidad electromagnética WEEE Aprobado.
- EMC Aprobado.



Código	Casquillo	Luz	W	Lumen		Precio Oferta	Precio Oferta
Lámpara Globo led 220V							
31161	E27	3000K	16	1400	50	16,50	7,70
31162	E27	4200K	16	1400	50	16,50	7,70

- Vida útil: 25.000 horas.

175-240V / 50-60Hz

Medidas: 138X95



Lámpara Globo led 220V

31164	E27	3000K	20	1620,00	20	19,70	9,20
31165	E27	4200K	20	1620,00	20	19,70	9,20

175-240V / 50-60Hz

Medidas: 138X95

- Vida útil: 25.000 horas.



Código	Color	Wattios	Lumen	Luz		Precio tarifa	Precio Oferta
Lampara E27 campana LED COB							
49955	Aluminio	40W	3200	6400K	1	42,60	18,90
49957	Aluminio	60W	4800	6400K	1	59,60	25,90

- Medidas: 300mm de ancho x 180mm de alto.

**Oferta  
neto**

Código	Rosca	Luz	Lumen		Precio €	
--------	-------	-----	-------	---	----------	--

Lámpara opal tipo esférica de Led  
220-240V 50-60Hz. 6W.

**6W**

67807	E14	4200K	600	10	<b>9,90</b>	<b>3,95</b>
67808	E14	6400K	600	10	<b>9,90</b>	<b>3,95</b>



Lámpara opal tipo vela de Led  
220-240V 50-60Hz. 6W.

**6W**

67800	E14	3000K	580	10	<b>9,90</b>	<b>3,95</b>
67801	E14	4200K	580	10	<b>9,90</b>	<b>3,95</b>
67802	E14	6400K	580	10	<b>9,90</b>	<b>3,95</b>



Lámpara opal tipo vela punta de Led  
220-240V 50-60Hz. 6W.

**6W**

67804	E14	4200K	580	10	<b>9,90</b>	<b>3,95</b>
-------	-----	-------	-----	----	-------------	-------------



Lámpara PL Leds 175-250Vac - 50-60Hz.

67590	G24	4200K	10	10	<b>17,80</b>	<b>8,70</b>
67591	G24	6400K	10	10	<b>17,80</b>	<b>8,70</b>

- Apertura 110° Medida: 145mm. diam. 38mm. Lumenes 980



Lámpara globo LED 20W

67825	E27	4200K	20	5	<b>39,90</b>	<b>18,50</b>
67826	E27	6400K	20	5	<b>39,90</b>	<b>18,50</b>

- Apertura: 310°. Lumenes 1900  
- Medida: Diam.145Xaltura190

# INDUSTRIALES

- Funcionamiento estándar entre  $-25^{\circ}\text{C}$  y  $50^{\circ}\text{C}$ .
- Cuando la temperatura ronda los  $70^{\circ}\text{C}$  la lámpara se apaga por seguridad y cuando alcanza entre los  $50^{\circ}\text{C}$  y  $60^{\circ}\text{C}$  se enciende automáticamente.



Código	Rosca	Lum.	Luz		Precio €	oferta neto
--------	-------	------	-----	---	----------	-------------

Lámpara led 220-240V.

67832	E27	3800	6400K	10	108,00	43,90
-------	-----	------	-------	----	--------	-------

- Medida: 160x78mm.
- Apertura  $120^{\circ}$ .
- Numero de led: 90.

## 40W

Lámpara 220-240V. Led, 50mm.

67835	E27	6600	6400K	5	149,00	56,90
-------	-----	------	-------	---	--------	-------

- Medida: 170x78mm.
- Apertura  $120^{\circ}$ .
- Numero de led: 130.

## 70W

Lámpara 220-240V. Led, 50mm.

67838	E27	9500	6400K	5	192,00	69,90
-------	-----	------	-------	---	--------	-------

- Medida: 198x88mm.
- Apertura  $120^{\circ}$ .
- Numero de led: 220.

## 100W

Lámpara 220-240V. Led, 50mm.

67841	E40	14200	6400K	5	345,00	109,00
-------	-----	-------	-------	---	--------	--------

- Medida: 230x114mm.
- Apertura  $120^{\circ}$ .
- Numero de led: 290..

## 150W



### ADVERTENCIA:

No colocar nunca en apliques o campanas cerradas, es importante que esté ventilado.



# Tubos de cristal LED SKYLIGHTING



Precio €  
oferta  
neto



Código	Medida	Luz	W	Lumen		Precio € oferta neto
Tubos T8 de Leds						
67933	600mm	4200°K	10W	900	5 / 10	<b>5,70</b>
67935	1200mm	4200°K	18W	1700	5 / 10	<b>7,90</b>
67937	1200mm	4200°K	24w	2300	5 / 10	<b>10,90</b>
67939	1500mm	4200°K	24W	2300	5 / 10	<b>12,90</b>
67940	1500mm	6400°K	24W	2400	5 / 10	<b>12,90</b>

- Eficiencia energética: A+
- Base: **G13**
- Diámetro: **26mm**
- Vida útil: **30.000**
- Dimable: **No**
- Índice cromático: **Ra80**
- Caja intermedia: **5 pzs**
- Caja master: **10 pzs**

## Para sustituir tubos fluorescentes con balastro magnético

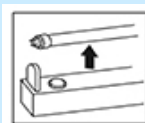

### Paso 1º

Cortar la corriente principal y quitar el tubo fluorescente.

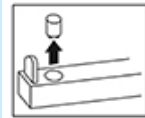

### Paso 2º

Poner el cebador que trae el tubo.

### Paso 3º

Coloque el tubo de LED.

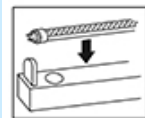

### Importante:

En este caso la luminaria será conforme al estándar de la CE.

## Para sustituir tubos fluorescentes con balastro electrónico

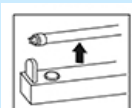

### Paso 1º

Cortar la corriente principal y quitar el tubo fluorescente.

### Paso 2º

Anular el balastro, desechar el cebador suministrado y conectar cada polo a un solo borne de cada extremo del tubo, los otros dos bornes restantes deben conectarse entre si.



**Giratorio 90º**

Medidas: 600X26 mm.  
1200X26 mm.  
1500X26 mm.



RGB los SMD de 35X28 sólo llevan un color por led; rojo, verde y azul intercalados

RGB los SMD de 50X50 llevan los colores en el mismo led mas blanco lo cual permite hacer múltiples colores

Código	Medida	IP	Luz	W		Precio €	Oferta Neto
<b>Disco de LED con transformador incorporado</b>							
47965	180X30		3000	18W	10	18,40	4,90
47968	180X30		3000	22W	10	19,60	5,90

- 220-240V - 50Hz.
- Medidas: 180x30 mm.
- SMD LED 56x30, 48 pzas.
- Incluye 2 pinzas para downlight.

- Apertura 120°.
- Con 4 imanes.
- 30,000 horas.

#### Kit tira led 14,4W con controlador y transformador inclu.

4122235	RGB		RGB	14,4W	6	42,90	19,90
---------	-----	--	-----	-------	---	-------	-------

- La tira tiene tres metros 4,8 watos x metro.
- 60 SMD de 35X28m por metro.
- Los RGB de 35X28 son los 3 colores básicos.
- 288 lúmenes x metro.
- Base adhesiva.
- Presentación en blister



#### Tira led 5mts

HL540LF	5m	65	4200K	24W	1	18,30	8,50
HL540W	5m	65	6400K	24W	1	18,30	8,50
HL540R	5m	65	RGB	24W	1	22,90	10,70

- 4,8 watos x metro.
- 60 SMD de 35X28m por metro.
- Los RGB de 35X28 son los 3 colores básicos.
- 288 lúmenes x metro.
- Base adhesiva.
- Presentación en bolsa individual.

#### Tira led 5mts

HL542W	5m	65	6400K	72W	1	39,00	18,50
HL542R	5m	65	RGB+W	72W	1	51,70	24,90

- 14,4 watos x metro.
- 60 SMD de 50X50m por metro.
- Los RGB+W de 50X50 se pueden hacer múltiples colores
- 864 lúmenes x metro.
- Base adhesiva.
- Presentación en bolsa individual.



Código	Lumen Rollo	IP		W / M		Precio €
Rollo Tira led 50mts						X Metro
HL543A	30000	65	3000K	10	50	5,90
HL543L	30000	65	6400K	10	50	5,90
HL543B	30000	65	AZUL	10	50	5,90
HL543G	30000	65	VERDE	10	50	5,90
HL543R	30000	66	ROJO	10	50	5,90

- Voltage 220-240V / 50-60Hz.

- 2 lineas tira de 7mm x 3mm

- 10 watos x metro.

- 600 Lm. X metro.

- 1 metro 60 Led tipo 50X50 SMD.

- Angulo 120°.

- Rollos de 50 mts. [Con 1 bolsa de accesorios por rollo](#)



**PUEDA  
CORTARSE  
CADA 1 MT.**



**Cada bolsa de accesorios contiene:**

- Conexión a red: 1 ud.

- Pincho de conexión: 1 ud.

- Empalme de conexión: 1 ud.

- Tapón: 1 ud.

- Grapas: 5 uds.



**2,40 €  
por metro**

Rollo Tira led 50mts

41986	30000	65	6400K	10	50	4,90
-------	-------	----	-------	----	----	------

- Voltage 220-240V / 50-60Hz.

- 2 lineas tira de 7mm x 3mm

10 watos x metro.

- 600 Lm. X metro.

- 1 metro 60 Led tipo 50X50 SMD.

- Angulo 120°.

- Rollos de 50 mts.

Con 1 conexión a tira



**PUEDA  
CORTARSE  
CADA 1 MT.**



Repuesto para tira HL543

HL54	Conexión a red			10	6,40
HL55	Empalme conexión			5	1,20
HL56	Tapon			10	0,30
HL57	Grapas			10	0,30

41991	Set			10	9,40
-------	-----	--	--	----	------

**Cada set contiene:**

- Conexión a red: 1 ud.

- Pincho de conexión: 1 ud.

- Empalme de conexión: 1 ud.

- Tapón: 1 ud.

- Grapas: 5 uds.





Código	Lumen	Rollo	IP	W / M		Precio €
Rollo Tira led 100mts						
41985	3100	44	Blanca	1,8	100	<b>4,60</b>

- Voltage 220-240V / 50-60 Hz.
- 2 líneas - tubo de 13mm.
- 1,8 wátios x metro.
- 30 lamp. por metro.
- 31 lúmenes x metro,
- 10 bolsas de accesorios,
- Presentación en rollo de 100 metros.







#### Set de accesorios incluidos en cada rollo

- 10 conexiones a red.
- 10 conexiones entre tiras.
- 10 tapones finales.

Código	Rosca	Medida	Lumen		Precio €
Lámpara standar 16 colores led, 4W, 5 programas y mando.					
010653	E27	69,5X45	105	12	<b>10,60</b>







Lámpara colores esféricas SMD LED, 20.000 hr. Vida  
220-240V 50-60Hz.

31075	E27		69,5X45	105	10	<b>1,98</b>
31076	E27		69,5X45	34	10	<b>1,98</b>
31077	E27		69,5X45	68	10	<b>1,98</b>
31078	E27		69,5X45	12	10	<b>1,98</b>

- Tipo de LED SMD.
- Compatibilidad electromagnética WEEE Aprobado.
- EMC Aprobado.

Lámpara opal tipo standar de Led

31079	E27		110X60	315	10	<b>5,60</b>
31080	E27		110X60	102	10	<b>5,60</b>
31081	E27		110X60	205	10	<b>5,60</b>
31082	E27		110X60	38	10	<b>5,60</b>

**1W**



**3W**





IP20

- Transfor. electrónico para leds.
- Entr. 220-240AC - Sal. 12V DC.
- Medidas: 77X50X20.
- Medidas: 85X58X37.

Código	W	P.V.
HL544	10-0,8A	7,60
HL545	36-3A	11,80



IP20

- Transfor. electrónico para leds.
- Entr. 220-240AC - Sal. 12V DC.
- Medidas: 110X78X35.
- Medidas: 168X98X38.

Código	W	P.V.
HL546	60-5A	16,80
HL547	120-10A	23,90



IP20

- Transfor. electrónico para leds.
- Entr. 220-240AC - Sal. 12V DC.
- Medidas: 200X98X42
- Medidas: 200X110X50.

Código	W	P.V.
HL548	150-12A	27,90
HL549	200-17A	34,80



IP65

- Transfor. electrónico para leds.
- Entr. 220-240AC - Sal. 12V DC.
- Medidas: 180x30x20.

HL553	25-2A	13,90
-------	-------	-------



IP65

- Transfor. electrónico para leds.
- Entr. 220-240AC - Sal. 12V DC.
- Medidas: 180x70x40 mm.

HL555	60-5A	31,60
-------	-------	-------



IP65

- Transfor. electrónico para leds.
- Entr. 220-240AC - Sal. 12V DC.
- Medidas: 252x70x40 mm.

HL557	120-10A	54,20
-------	---------	-------



IP68

- Transfor. electrónico para leds.
- Entr. 220-240AC - Sal. 12V DC.IP68

77140	60	36,90
-------	----	-------



- Conexión ó para curvas 4 hilos.
- 15cm.

41964	RGB	3,10
-------	-----	------



- Conexiones a red para tiras de leds.
- 1 macho y 1 hembra de 15 cm.
- Se puede utilizar como empalme de dos tiras ó para conectar a red.

41965	10 sets	2,30
-------	---------	------



IP20

**CONTROL REMOTO**

- Controlador RGB+mando Max.144W.
- Entr. DC12-24V Sda. DC12-24V.

41946	4A	28,90
-------	----	-------



**CONTROL REMOTO**

- Controlador RGB+mando Max.72W.
- Entr. DC12-24V Sda. DC12-24V.

HL560	2A	8,40
-------	----	------

- El controlador - 41946 es para tira de :
  - 35X28 SMD máx.. 30 mts.
  - 50X50 SMD máx.. 10 mts.
- El controlador - HL560 es para tira de - 35X28 SMD máx.. 15 mts.
- 50X50 SMD máx.. 5 mts.



# MINI

## Lámparas espirales



E-14

Código	Rosca	Color	W		Precio	Precio Neto
Mini espiral T2 220-240V						
41111	E14	2700	10	10/50	4,60	1,50
41121	E14	6400	10	10/50	4,60	1,50

- Medidas 10W: 90x35mm.



E-14

E-27



Mini espiral T2 220-240V						
41113	E14	2700	12	10/50	4,90	1,75
41124	E27	6400	12	10/50	4,90	1,75

- Medidas 12W: 91x42mm.



67400	E27	6400K	40	10/50	10,80	4,90
-------	-----	-------	----	-------	-------	------

- Medidas: 144X72mm.



15W

Código	Color	V	W			
Lámpara bajo consumo 220-230V GU10 15W						
41301	GU10	2700K	15	10/50	8,80	0,95
41302	GU10	4100K	15	10/50	8,80	0,95

- Tubos T2. Lumenes 750  
 - 8.000 horas de vida.  
 - Medidas: 97X32mm.





# Lámparas MINI



**8.000 Horas**

Código	Rosca	Color	W	Tbos.		Precio	Precio Neto
Súper minis bajo consumo 220-240V							
41224	E14	2700	11	6U	10/50	<b>5,80</b>	<b>0,99</b>
41225	E14	2700	15	6U	10/50	<b>6,30</b>	<b>0,99</b>
41210	E14	2700	9	3U	10/50	<b>5,30</b>	<b>0,75</b>
41201	E14	4100	9	3U	10/50	<b>5,30</b>	<b>0,75</b>
41211	E14	6400	9	3U	10/50	<b>5,30</b>	<b>0,75</b>
41214	E14	2700	15	3U	10/50	<b>6,30</b>	<b>0,75</b>
- Medidas: 100X35mm.							
41182	E27	2700K	15	3	10/50	<b>3,90</b>	<b>1,50</b>
- Medidas: 125X41mm.							
41184	E27	2700K	20	4	10/50	<b>4,70</b>	<b>1,50</b>
- Medidas: 120X47mm.							
41185	E27	2700K	24	4	10/50	<b>4,90</b>	<b>1,95</b>
- Medidas: 130X47mm.							
41280	E27	6400K	32	4	10/50	<b>8,90</b>	<b>3,50</b>
- Medidas: 190X58mm.							
41282	E27	6400K	65	4	10/50	<b>18,90</b>	<b>5,95</b>
- Medidas: 245X70mm.							



Presentación  
caja a color



**12W**



**15W**



**20W**



**24W**



**105W**



**85W**



**65W**



**45W**

Modelo	Medidas	Rosca	Luz	Vatios	Tube	Lumen		Precio Tarifa	Precio Oferta
Lámparas bajo consumo 220-240V 50-60Hz.									
41010	107X37	E27	6400K	12W	T3	500	10	<b>4,20</b>	<b>1,75</b>
41017	107X45	E27	6400K	12W	T3	540	10	<b>4,50</b>	<b>1,95</b>
41020	128X45	E27	6400K	15W	T3	750	10	<b>4,70</b>	<b>1,95</b>
41023	126X54	E27	6400K	20W	T3	1020	10	<b>5,40</b>	<b>2,40</b>
77847	150X58	E27	VERDE	24W	T3	600	10	<b>6,80</b>	<b>2,95</b>
41038	174X83	E27	6400K	45W	T4	1750	10	<b>12,80</b>	<b>5,90</b>
41040	174X83	E27	6400K	65W	T5	2500	10	<b>15,90</b>	<b>6,90</b>
41041	174X105	E27	6400K	85W	T5	3500	10	<b>24,70</b>	<b>11,60</b>
41043	174X105	E27	6400K	105W	T6	4400	10	<b>28,90</b>	<b>12,80</b>

- Vida media: 6.000 horas.





Código	Rosca	V	W		Precio €
--------	-------	---	---	---	----------

Lámpara PL bajo consumo 2PIN

41449	G24d1	4000K	13	25/100	<b>3,40</b>
-------	-------	-------	----	--------	-------------

- Medidas: 135X27mm.

Lámpara PL bajo consumo 4PIN

41461	G24q1	4000K	13	25/100	<b>3,40</b>
-------	-------	-------	----	--------	-------------

- Medidas: 135X27mm.

Lámpara PL bajo consumo 2PIN

41453	G24d3	2700K	26	25/100	<b>3,40</b>
-------	-------	-------	----	--------	-------------

41454	G24d3	4000K	26	10/100	<b>3,40</b>
-------	-------	-------	----	--------	-------------

41455	G24d3	6400K	26	10/100	<b>3,40</b>
-------	-------	-------	----	--------	-------------

- Medidas: 170X27mm.



Lámpara L 4 PIN

77273	2G11	4000K	18W	10	<b>4,75</b>
-------	------	-------	-----	----	-------------

- Medidas: 225X38mm.

77279	2G11	4000K	36W	10	<b>7,20</b>
-------	------	-------	-----	----	-------------

- Medidas: 415X38mm.

77282	2G11	4000K	55W	10	<b>8,60</b>
-------	------	-------	-----	----	-------------

- Medidas: 535X38mm.

Lámpara S 2 PIN

41468	G23	4000K	9	10	<b>3,40</b>
-------	-----	-------	---	----	-------------

41469	G23	4000K	11	10	<b>3,70</b>
-------	-----	-------	----	----	-------------



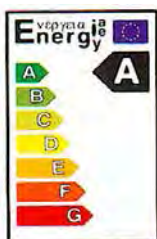

Código	Tubo	Med.	W	Luz		Precio €
<b>Mini tubo</b>						
41621	T-5	212	6	6500	25	<b>1,60</b>
41622	T-5	288	8	6500	25	<b>1,80</b>
41623	T-5	517	13	6500	25	<b>2,40</b>

<b>Tubo T8 Halofósforo, 6.500°K - Medidas especiales</b>						
41655	T-8	450	15	6500	25	<b>2,20</b>
41656	T-8	900	30	6500	25	<b>2,70</b>

<b>Tubo T8 Halofósforo 6500K</b>						
41650	T-8	600	18	6500	25	<b>1,90</b>
41651	T-8	1200	36	6500	25	<b>2,20</b>

<b>Tubo T8 Plus trifósforo, 6.500°K, Vida media 20.000 horas</b>						
41624	T-8	600	18	4000	25	<b>2,60</b>
41625	T-8	600	18	6500	25	<b>2,60</b>
41626	T-8	1200	36	4000	25	<b>3,20</b>
41627	T-8	1200	36	6500	25	<b>3,20</b>
41628	T-8	1500	58	4000	25	<b>4,20</b>
41629	T-8	1500	58	6500	25	<b>4,20</b>

**FABRICADO EN LA UNIÓN EUROPEA**

<b>Tubo circular trifósforo T-9 luz día</b>						
41635	T-9	216	22W	6500	12	<b>5,20</b>
41636	T-9	305	32W	6500	12	<b>6,60</b>

<b>Luz negra ( BL350) Gama de Tubos especiales exterminador de insectos, señuelos, etc</b>						
41640	T-5	212	6		10	<b>3,80</b>
41641	T-5	288	8		10	<b>4,20</b>
41642	T-8	438	15		10	<b>5,60</b>
41643	T-8	590	20		10	<b>6,50</b>



**Anti-insectos**

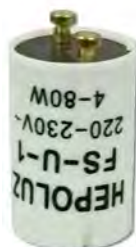
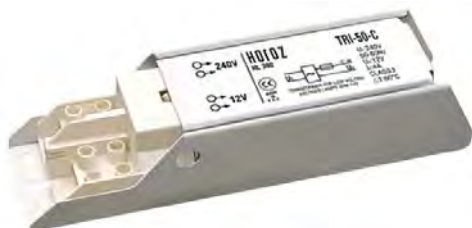

Código	Tubo	W		Precio €
<b>Balastro electrónico 230V 50/60 Hz.</b>				
HL382	230V 50/60hZ	18	12	<b>5,40</b>
HL384	230V 50/60hZ	36	12	<b>6,40</b>
HL385	230V 50/60hZ	2x18	12	<b>8,40</b>
HL386	230V 50/60hZ	2x36	12	<b>11,40</b>

- 200x20mm 18/36
- 240x30mm 2x18/2x36

**Equipo Reactancia tipo 230V 50/60 Hz.**

47939	230V 50/60hZ	2X13	6	<b>3,80</b>
47940	230V 50/60hZ	2X26	6	<b>3,80</b>

- Para Downlight. de 2X13Wy 2X26W

**Transformador 240V a 12V 50/60 Hz.**

HL360	230V-12V 50/60hZ	50	10	<b>6,90</b>
-------	------------------	----	----	-------------

- Para lámparas halógena.

**Transformador electrónico 240V a 12V 50/60 Hz.**

HL370	230V-12V 50/60hZ	60	10	<b>6,90</b>
-------	------------------	----	----	-------------

- Para lámparas halógena.

**Cebadores Sylvania 220-240V**

0024432	FS 11 - 4-65W		25/250	<b>0,80</b>
0024433	FS 22 - 4-22W		25/250	<b>0,86</b>

**Cebadores Hepoluz 220-240V**

41530	FS-U-1 4-22		48	<b>0,55</b>
41525	FS-U-2 4-80		20	<b>0,55</b>

**Cebadores en blíster**

41521	FS-U-1 4-22		20	<b>0,95</b>
41523	FS-U-2 4-80		20	<b>0,95</b>

# APLIQUES DE TECHO Y PARED

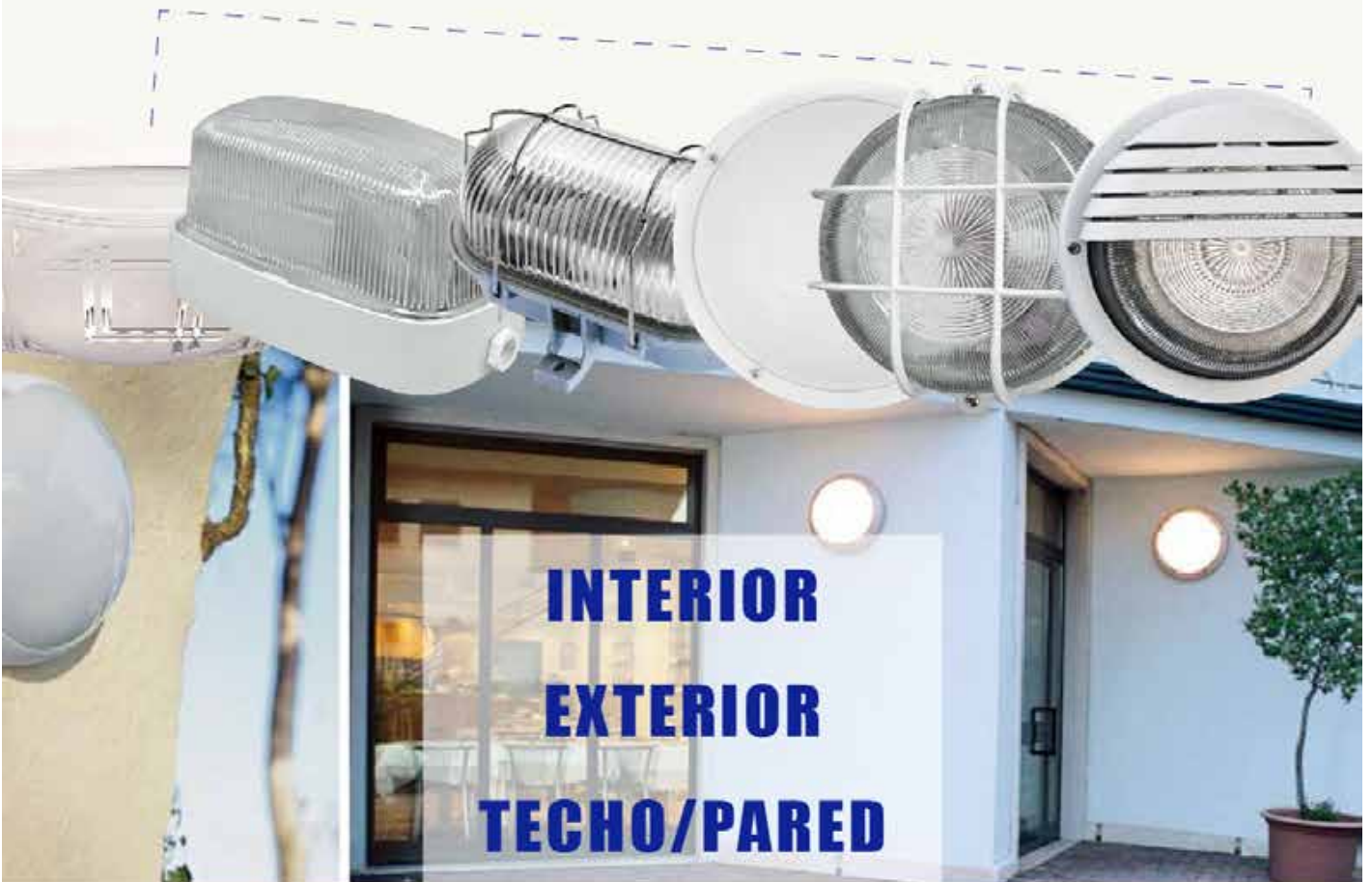

**VARIEDAD**  
**PRÁCTICOS**  
**DECORATIVOS**  
**MODERNOS**



Rejilla  
metálica



Pantalla  
de cristal



Cajas completas

Precio €

Oferta

Código

Modelo



Precio €

Aplique estándar con soporte

Código	Modelo	Box	Precio €	Oferta
4256111	Negro	4	5,60	2,59
4256112	Blanco	4	5,60	2,59
4256210	Gris	4	5,60	2,59

- Medidas: 175X125mm.
- IP43.
- Clase II máx.60W.
- 250V 1xE27.



VDE IP44

Aplique gris metálico con rejilla

Código	Modelo	Box	Precio €	Oferta
4256200	Gris-60W	4	6,30	2,95
4256300	Gris-100W	2	10,80	4,95

- Medidas: 170X125mm.
- IP43.
- Clase II máx.
- 250V 1xE27.



VDE IP44

Aplique con rejilla

Código	Modelo	Box	Precio €	Oferta
4266001	Negro	6	10,80	4,95
4266002	Blanco	6	10,80	4,95

- Medidas: Ø 220mm.
- IP44.
- Clase II máx. 75 máx.
- 250V 1xE27.
- Pantalla de cristal.



VDE IP44

# SERIE ALUMINIO



Cajas completas

Código	Modelo		Precio tarifa	Precio Oferta
Aplicques plano E27 máx. 60W				
HL901B	Blanco	12	8,80	3,95
HL901N	Negro	12	8,80	3,95

Medidas: 210x105x85.

Aplicques plano E27 max. 100W

HL921B	Blanco	12	16,70	6,95
HL921N	Negro	12	16,70	6,95

Medidas: 275x155x120.

Aplicques plano redondo. E27 máx. 60W

HL906B	Blanco	12	9,20	3,95
HL906N	Negro	12	9,20	3,95

Medidas: 170x80.

Aplicques plano redondo. E27 máx. 100W

HL926B	Blanco	12	17,30	7,75
HL926N	Negro	12	17,30	7,75

Medidas: 240x115.

Aplicques plano E27 máx. 60W

HL911B	Blanco	12	23,40	9,95
HL911N	Negro	12	23,40	9,95

Medidas: 265x130x105.

Aplicques plano E27 max. 60W

HL902B	Blanco	12	9,60	4,25
HL902N	Negro	12	9,60	4,25

Medidas: 210X105X85.

Aplicques redondo E27 máx. 60W

HL907B	Blanco	12	9,90	4,45
HL907N	Negro	12	9,90	4,45

Medidas: 170x80.



Cajas completas

Código	Modelo		Precio tarifa	Precio oferta
Apliques estancos para 60W				
42470	redondo IP43	6	13,90	6,50

- Portalámparas 1xE27.
- ABS.
- Medidas: 117.

Aplique estanco inclinado para 100W

42460	oval inclin. IP54	6	8,70	3,95
-------	-------------------	---	------	------

- Portalámparas 1xE27.
- ABS.
- Medidas: 184x104.

Aplique MD. AQUA EKO

42235	Blanco	18	8,90	3,75
42236	Negro	18	8,90	3,75

- 230V - 50Hz. Max. 60W.
- Lámpara no incluida.
- Medidas: 228X228x97.

Aplique red. máx. 60W 220-240V 1 X E27

42611	Negro	6	14,90	5,95
-------	-------	---	-------	------

- Carcasa en polipropileno.
- Pantalla de policarbonato.
- Medidas: 260X130mm.
- IP44.

Presentación en caja a color.

Cajas completas

**Precio** **Precio**  
**Tarifa** **Oferta**



Código	Color		Precio Tarifa	Precio Oferta
<b>Aplique MD. GLOP</b>				
42202	Blanco	4 / 32	<b>5,80</b>	<b>2,20</b>

- 230V - 50Hz. Max. 40W .
- Lámpara no incluida.
- Medidas: 230X91mm.
- Presentación granel.
- 4 unidades por caja.



Código	Color	Unidades	Precio Tarifa	Precio Oferta
<b>Aplique MD. UFO</b>				
42203	Blanco / Rayas	5 / 40	<b>4,80</b>	<b>1,95</b>
42204	Blanco / Liso	5 / 40	<b>4,80</b>	<b>1,95</b>

- 230V - 50Hz. Máx. 40W.
- Lámpara no incluida.
- Medidas: 230X82,5mm.
- Presentación granel.
- 5 unidades por caja.



Código	Color	Unidades	Precio Tarifa	Precio Oferta
<b>Aplique MD. OVAL</b>				
42210	Blanco / Liso	4 / 36	<b>5,20</b>	<b>1,95</b>
42211	Blanco / Deco	4 / 36	<b>5,20</b>	<b>1,95</b>

- 230V - 50Hz. Máx. 26W B.Con.
- Lámpara no incluida.
- Medidas: 270x165x81.
- Presentación granel.
- 4 unidades por caja.











**ESTOS APLIQUES PUEDEN IR CON BOLSA SOLAPA,  
SOLO SE AÑADE UN 0 AL FINAL DEL CÓDIGO Y 1,50€ AL PRECIO TARIFA**



cajas completas



Código	Color		Precio Tarifa	Precio Oferta
<b>Aplique Md-Lolly rectangular interior-exterior</b>				
42240	Blanca	5 / 60	<b>3,80</b>	<b>1,20</b>
- 220-240V , 1XE27. - Bajo consumo max. 15W. - Medidas: 225X74X70.				
<b>Aplique MD. APLIK IP65</b>				
42242	Blanco	10	<b>7,40</b>	<b>2,95</b>
- 230V - 50Hz. Max. 40W. - Anti golpes. - Lámpara no incluida. - Medidas: 200X85.				
<b>Aplique MD. AQUA EKO</b>				
42243	Negro	10	<b>7,40</b>	<b>2,95</b>
- 230V - 50Hz. Max. 40W. - Anti golpes - Lámpara no incluida. - Medidas: 200X85.				
   				
<b>Aplique MD. APLIK IP54</b>				
42238	Blanco	10	<b>7,40</b>	<b>2,95</b>
- 220-240V - 50Hz. E27 Max. 1X26W. - Pantalla de policarbonato. - Lámpara no incluida. - Medidas: 246X140mm.				
   				
<b>Aplique MD. APLIK IP54</b>				
42239	Negro	10	<b>7,40</b>	<b>2,95</b>
- 220-240V - 50Hz. E27 Max. 1X26W. - Pantalla de policarbonato. - Lámpara no incluida. - Medidas: 246X140mm.				

**ESTOS APLIQUES PUEDEN IR CON BOLSA SOLAPA, AÑADIR UN 0 AL FINAL DEL CÓDIGO Y 1,50€AL PRECIO TARIFA**

Cajas completas

Precio € Precio €  
Tarifa Oferta



Código	Color		Precio € Tarifa	Precio € Oferta
<b>Aplique MD. KARE MODERN</b>				
42213	Blanco	1 / 12	10,60	2,95

- Lámpara no incluida.
- Medidas: Diámetro 255X81mm.
- Presentación caja color 1.
- Máx. 1x26W (ESL).



**Aplique MD. KARE MODERN BIG**

42214	Blanco	1 / 10	17,60	5,95
-------	--------	--------	-------	------

- Lámpara no incluida.
- Medidas: Diámetro 323X89mm.
- Presentación caja color 1.
- Máx. 2x26W (ESL).



**Aplique MD. ZAGREP**

42215	Blanco	1 / 5	18,40	6,95
-------	--------	-------	-------	------

- Lámpara no incluida.
- Medidas: Diámetro 377X117mm.
- Presentación caja color 1.
- Máx. 2x26W (ESL).



↑ **CON SENSOR**







↑ **CON SENSOR**



↑ **CON SENSOR**



↑ **CON SENSOR**

Código	Modelo		Precio tarifa
<b>Aplique con sensor</b>			
42617	Gota	10	26,90
<ul style="list-style-type: none"> <li>- Base metal - cubierta cristal.</li> <li>- 220-240V , 2X27.</li> <li>- IP20</li> <li>- Bajo consumo max. 2x25W.</li> <li>- Sensor de movimiento 360°</li> <li>- Sensor de luz 2 a 240 lux.</li> <li>- Temperatura de trabajo -20°C a +50°C.</li> <li>- Tiempo: 15 a 270 seg.</li> <li>- Medidas: 300mm.</li> </ul>			 <b>OFERTA</b> <b>11,90€</b>
<b>Aplique con sensor</b>			
42246	Rombo	10	26,90
<ul style="list-style-type: none"> <li>- Base metal - cubierta cristal.</li> <li>- 220-240V , 2X27.</li> <li>- IP20.</li> <li>- Bajo consumo max. 2x25W.</li> <li>- Sensor de movimiento 360°</li> <li>- Sensor de luz 2 a 240 lux.</li> <li>- Temperatura de trabajo -20°C a +50°C.</li> <li>- Tiempo 15 a 270 seg.</li> <li>- Medidas: 300mm.</li> </ul>			 <b>OFERTA</b> <b>11,90€</b>
<b>Aplique con sensor</b>			
42618	Cuadro	10	26,90
<ul style="list-style-type: none"> <li>- Base metal - cubierta cristal.</li> <li>- 220-240V , 2X27.</li> <li>- IP20.</li> <li>- Bajo consumo max. 2x25W.</li> <li>- Sensor de movimiento 360°</li> <li>- Sensor de luz 2 a 240 lux.</li> <li>- Temperatura de trabajo -20°C a +50°C.</li> <li>- Tiempo 15 a 270 seg.</li> <li>- Medidas: 300mm.</li> </ul>			 <b>OFERTA</b> <b>11,90€</b>
<b>Aplique con sensor</b>			
42619	Liso	10	26,90
<ul style="list-style-type: none"> <li>- Base metal - cubierta cristal.</li> <li>- 220-240V , 2X27.</li> <li>- IP20.</li> <li>- Bajo consumo max. 2x25W.</li> <li>- Sensor de movimiento 360°</li> <li>- Sensor de luz 2 a 240 lux.</li> <li>- Temperatura de trabajo -20°C a +50°C.</li> <li>- Tiempo 15 a 270 seg.</li> <li>- Medidas: 300mm.</li> </ul>			 <b>OFERTA</b> <b>11,90€</b>

Cajas completas

**Precio**  
tarifa **Precio**  
oferta



Código	Color		Precio tarifa	Precio oferta
Aplique MD. AQUA RED.				
42220	Blanco	10	18,80	6,95

Aplique MD. AQUA RED.				
42221	Negro	10	18,80	6,95

Aplique MD. AQUA RED.				
42222	Gris	10	18,80	6,95

- 230V - 50Hz. Max. 60W.
- Lámpara no incluida.
- Medidas: Diám 275x99mm.

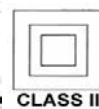

Aplique MD. AQUA OVAL				
42230	Blanco	10	18,80	6,95

Aplique MD. AQUA OVAL				
42231	Negro	10	18,80	6,95

Aplique MD. AQUA OVAL				
42232	Gris	10	18,80	6,95

- 230V - 50Hz. Max. 60W.
- Lámpara no incluida.
- Medidas: 325X235x98.





Cajas completas

Código	Color		Precio tarifa	Precio oferta
Aplique MD. 1/2 LUNA OPAL				
42250	Blanco	20	6,60	2,99
42251	Negro	20	6,60	2,99

Aplique MD. 1/2 LUNA SATIN

42252	Blanco	20	6,60	2,99
42253	Negro	20	6,60	2,99

- 230V - 50Hz. Max. 60W.
- Lámpara no incluida.
- Medidas: 250X200x105.



Anti-shock



CLASS II



IP54

Aplique MD. LUNA REDONDO OPAL

42254	Blanco	16	6,60	2,99
42255	Negro	16	6,60	2,99

Aplique MD. LUNA REDONDO SATIN

42256	Blanco	16	6,60	2,99
42257	Negro	16	6,60	2,99

- 230V - 50Hz. Max. 60W.
- Lámpara no incluida.
- Medidas: Diám 245x105mm.



Anti-shock



CLASS II



IP54



**OFERTA**  
**9,90€**

**OFERTA**  
**11,90€**



**OFERTA**  
**10,95€**



**OFERTA**  
**10,95€**

Código	Modelo		Precio tarifa
<b>Aplique MD. AQUA LED 18W</b>			
42228	Blanco	18	<b>26,90</b>
42229	Negro	18	<b>26,90</b>

<b>Aplique MD. AQUA LED 22W</b>			
42233	Blanco	18	<b>26,90</b>
42234	Negro	18	<b>26,90</b>

- 230V - 50Hz. Lumenes - 1400 y 1700  
- Medidas: 228X228x97.



<b>Aplique REDONDO LED 12W</b>			
42750	Blanco	6	<b>24,50</b>

- Carcasa en polipropileno.  
- Medidas: 220X98mm.  
- IP54. LUZ 4000K **900 LUMENES**

**Presentación en caja a color.**



<b>Aplique OVAL LED 12W</b>			
42752	Blanco	6	<b>24,50</b>

- Carcasa en polipropileno.  
- Medidas: 240X160X96mm.  
- IP54. LUZ 4000K **900 LUMENES**

**Presentación en caja a color.**





**6W**



**8W**



**12W**

Cajas completas

Código	Modelo		Precio tarifa	Precio oferta
--------	--------	---	---------------	---------------

Aplique led 6W 4000K				
42760	Liso	30	29,90	13,90
42761	Rejilla	30	29,90	13,90

Cuerpo de aluminio  
Medidas: 145x53mm



Aplique led 8W 4000K

42762	Liso	20	32,90	14,90
-------	------	----	-------	-------

Cuerpo de aluminio  
Medidas: 211x130x57



Aplique led 8W 4000K

42763	Rejilla	20	32,90	14,90
-------	---------	----	-------	-------

Cuerpo de aluminio  
Medidas: 211x130x57



Aplique led 12W 4000K

42764	Liso	20	42,90	19,90
-------	------	----	-------	-------

Cuerpo de aluminio  
Medidas: 220x67



Aplique led 12W 4000K

42765	Rejilla	20	42,90	19,90
-------	---------	----	-------	-------

Cuerpo de aluminio  
Medidas: 220x67



# APLIQUES PARA USO INTERIOR / EXTERIOR



Con detector de movimiento



15W  
19,90€



14W  
9,90€

18W  
12,90€

- Presentación en caja a color.  
- Kit completo

Código	Modelo		Precio tarifa
--------	--------	---	---------------

Aplique LED 15W 220-240V			
46190	Blanco	20	43,80

- Distancia de detección 8m max.24°.
- Cobertura de detección 180°.
- Tiempo de duración entre 8s. Y 180s.
- Altura de instalación entre 1,5mts. Y 3 mts.
- IP44.

Presentación en caja a color.



Aplique red. LED 14W 1000 Lm.

42615	Blanco	5	29,50
-------	--------	---	-------

Aplique red. LED 18W 1200 Lm.

42616	Blanco	5	34,60
-------	--------	---	-------

- Carcasa en polipropileno.
- IP42
- Luz 4000K
- Medidas: 260mm.
- Medidas: 300mm.







**360°** 

**CON SENSOR**

**CAPACIDAD DE INTERCONEXIONADO MAX. 300W**

**TASA ECO-RAEE = 0,50 €**  
**NO incluida en el precio**

Cajas completas

Código	Modelo	Medidas	Lúmenes	Nº LEDS	Color		Precio Tarifa	Precio Oferta
<b>PANTALLA ESTANCA SMD LED C/SENSOR</b>			<b>CUERPO DE PC + DIFUSOR DE ABS</b>					
43476	18W	600X86X65mm	1350	SMD 280	6000K	6	<b>79,60</b>	<b>21,90</b>
43477	36W	1200X86X65mm	2750	SMD 560	6000K	6	<b>138,90</b>	<b>39,90</b>



**TASA ECO-RAEE = 0,50 €**  
**NO incluida en el precio**

Cajas completas

Código	Modelo	Medidas	Lúmenes	Nº LEDS	Color		Precio Tarifa	Precio Oferta
<b>PANTALLA ESTANCA SMD LED</b>		<b>CUERPO DE PC + DIFUSOR DE ABS</b>						
43478	20W	600X73X70mm	1327	SMD 280	6000K	8	<b>32,40</b>	<b>14,90</b>
43473	32W	1200X86X70mm	2750	SMD 560	6000K	6	<b>42,60</b>	<b>19,90</b>

# Tubos LED de obsequio INCLUIDOS



Cajas completas

Código	Modelo	Medidas	Lúmenes		Color		Precio Tarifa	Precio Oferta
PANTALLA ESTANCA PARA TUBO LED			CUERPO DE PC + DIFUSOR DE ABS					
43481	9W	600X70X70mm	800		6000K	18	17,40	8,90
43482	18W	1200X70X70mm	1700		6000K	12	25,90	12,90
43483	24W	1500X70X70mm	2150		6000K	12	41,50	18,90

# Tubos LED de obsequio INCLUIDOS



Código	Modelo	Medidas	Lúmenes		Color		Precio Tarifa	Precio Oferta
PANTALLA ESTANCA PARA TUBO LED			CUERPO DE PC + DIFUSOR DE ABS					
43484	2X9W	600X105X70mm	1600		6000K	10	25,90	12,90
43485	2X18W	1200X105X70mm	3400		6000K	8	39,90	18,90
43486	2X24W	1500X105X70mm	4300		6000K	8	68,50	31,20

Alto  
factor



Alto  
factor



Código		Medida a		Precio € Tarifa	Precio € Oferta
<b>Pantalla estanca alto factor G13 - T8 - IP65</b>					
43518	1X18	660 mm.	6	<b>23,20</b>	<b>8,90</b>
43536	1X36	1270 mm.	6	<b>31,60</b>	<b>10,90</b>
43558	1X58	1570 mm.	6	<b>38,90</b>	<b>13,20</b>

- Medida c y b 90 y 100mm.
- Base fabricada en ABS y policarbonato irrompible.
- Reflector metálico lacado en blanco.
- Accesorios de cierre y sujeción en policarbonato irrompible.
- Juntas de neopreno.
- Cables de sujeción a la apertura.

**TASA ECO-RAEE = 0,50 €**  
**NO incluida en el precio**

**Pantalla estanca alto factor G13 - T8 - IP65**

43618	2X18	660 mm.	8	<b>29,40</b>	<b>9,90</b>
43636	2X36	1270 mm.	4	<b>45,60</b>	<b>15,90</b>
43658	2X58	1570 mm.	4	<b>54,50</b>	<b>20,90</b>

- Medida c y b 135x100mm.

**Pantalla estanca electrónica G13 - T8 - IP54**

43660	1X18	660 mm.	6	<b>19,90</b>	<b>9,90</b>
43661	1X36	1270 mm.	6	<b>29,10</b>	<b>12,90</b>
43662	2X18	660 mm.	6	<b>26,10</b>	<b>11,90</b>
43663	2X36	1270 mm.	6	<b>36,00</b>	<b>16,90</b>

- Medida c y b 100x100mm. Para la de un tubo.
- Medida c y b 140x100mm. Para la de dos tubos.
- Fabricada en polipropileno.

**TASA ECO-RAEE = 0,50 €**  
**NO incluida en el precio**

Medidas

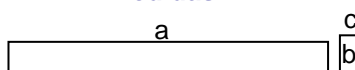

Fabricación nacional



Fabricación nacional



Código	Medidas a				Precio € Tarifa	Precio € Oferta
Regleta G13 - T8 - IP20 clase 1					Cajas completas	
43118	1X18	624 mm.	6	17,90	7,90	
43136	1X36	1233 mm.	6	19,90	9,60	
43158	1X58	1534 mm.	6	24,90	11,60	

- Medida c y b 60x83mm.

**TASA ECO-RAEE = 0,50 €  
Incluída en el precio**

Regleta G13 - T8 - IP20 clase1					Cajas completas	
43218	2X18	624 mm.	6	19,90	9,30	
43236	2X36	1233 mm.	6	29,80	14,70	
43258	2X58	1534 mm.	6	37,90	17,90	

- Medida c y b 136x41mm, Sin tubo.  
- IP20.

**TASA ECO-RAEE = 0,50 €  
Incluída en el precio**



Regleta G13 - T8 - IP20 clase1					Cajas completas	
HL150	1X18	624 mm.	12	12,90	5,40	
HL152	1X36	1233 mm.	12	13,80	5,90	

- Medida c y b 60x83mm.

**TASA ECO-RAEE = 0,50 €  
NO incluída en el precio**

Regleta G13 - T8 - IP20 clase1					Cajas completas	
HL151	2X18	624 mm.	12	14,80	5,90	
HL153	2X36	1233 mm.	12	19,80	8,90	

- Medida c y b 136x41mm, Sin tubo.  
- IP20.

**TASA ECO-RAEE = 0,50 €  
Incluída en el precio**

Mini regleta G13 - T8 - IP20 clase1					Cajas completas	
HL160	1X18	720 mm.	5	6,40	2,90	
HL161	1X36	1330 mm.	5	8,40	3,90	

- Medida c y b 50x52mm.

Mini regleta G13 - T8 - IP20 clase1					Cajas completas	
HL162	2X18	720 mm.	6	10,40	4,90	
HL163	2X36	1330 mm.	6	14,80	6,90	

- Medida c y b 40x73mm.

Mini regleta G13 - T8 - IP20 clase1					Cajas completas	
HL164	1X18	690 mm.	6	6,40	2,90	
HL165	1X36	1300 mm.	6	8,40	3,90	

- Medida c y b 50x38mm.

Todos los aparatos completos 220-240V, 50-60 Hz (Sin tubos)



cajas completas

## Tubos incluidos

- Tubo T8 / 220-240V / 50-60Hz.
- Transformador electrónico.
- Medidas: 638X104X42mm.
- Medidas: 1248X130X56mm.



Código	W		Precio € Tarifa	Precio € Oferta
Regleta electrónica con rejilla metálica				
45617	1 X 36	6	34,80	7,60

## Tubos incluidos



Mini Regleta de tubo T5 con interruptor.

45628	8W	6	13,60	3,90
45629	13W	6	16,20	4,90
HL200118	21W	6	19,60	6,90

- Tubo T5 220-240V / 50-60Hz.
- Especial bajo muebles, etc .
- Medidas: 340-572-900-1200-X42X22mm.
- **1,8 mt. de cable.**
- **Clavija para conectar.**
- **20 cm. de conexión para conectar entre ellas.**





Regleta de Led, 220-240V / 50-60 Hz. Luz 6400k

**OFERTA CAJAS COMPLETAS**

Código	Vatios	Medidas	Lumen		Precio €	Oferta neto
45210	18 W	600X70X27 mm.	1135	6	17,90	7,90
45211	36 W	1200X70X27 mm.	2269	6	26,60	11,90

# REGLETA LED

## tubo visto

**Equipo incluido**



Luz fría: 4.000°K



**NUEVAS MEDIDAS**



**OFERTA CAJAS COMPLETAS**

Regleta mod-T5 enlazable entre si con toma de corriente en ambos extremos

45666	5W	296X23X33mm.	380	12	10,90	3,39
-------	----	--------------	-----	----	-------	------

Regleta mod-T8 no enlazable entre si con toma de corriente solo en un extremo

45663	9W	600X30X36mm.	800	12	17,50	5,99
45665	20W	1200X30X36mm.	1800	6	21,50	6,99



LED

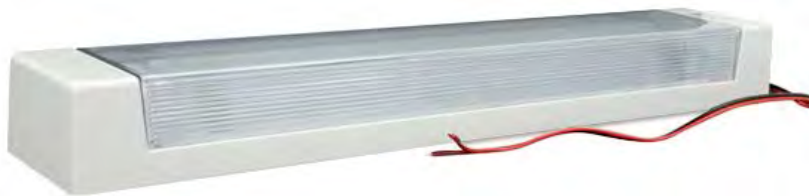

LED



Incluye conector



Cable conexión de 1,8 mts.

Código	Wat		Precio € Tarifa	Precio € Oferta
Regleta de emergencia <span style="float: right;">Cajas completas</span>				
438010	2 X 8	12	34,90	14,90

- Tubo 2 X 8W T5 / 220-240V / 50-60Hz.
- Batería recargable 6V 4Ah
- Autonomía: 90 minutos.
- Medidas: 400x70x60mm.
- Tubos incluidos



Regleta de emergencia <span style="float: right;">Cajas completas</span>				
438037	35 Led	6	42,40	18,90

- 35 led / 220-240V / 50-60Hz.
- Batería. recargable 6V 2,8Ah
- Autonomía: 5 horas
- Medidas: 290x80x70mm.



Regleta de 12V con interruptor.

4502040	1 X 8	12	22,10	8,90
---------	-------	----	-------	------

- Tubo de 8W. T5 12V
- Especial barcos, caravanas etc.
- Medidas: 400X70X60



Regleta de led 3W con interruptor.

45660	3 X 1	6	69,40	14,90
-------	-------	---	-------	-------

- 3 Led de 1W. 220-240V / 50-60Hz
- Especial bajo muebles etc.
- Con cable y clavija de 1,8 mts.
- Medidas: 430X53X26





IP20



IP20

LED



IP44

fabricación  
**NACIONAL**

LED



Precio €  
Tarifa

Precio €  
Oferta

Código	W	Lm.	m <sup>2</sup>		Precio € Tarifa	Precio € Oferta
Luces de emergencia					Cajas completas	
HL306	6	70	14	10	19,40	8,90
HL308	8	103	20	10	20,90	9,90

- Tubo T5 / 220-240V / 50-60Hz.
- Batería. 2 x 4V 0,9Ah recargable
- Autonomía: 90 minutos.
- 1 x 6-Medidas: 245 x 75 x 45mm.
- 1 x 8-Medidas: 325 x 75x 45mm.

HL306L	1,8	90	14	10	22,60	9,90
HL308L	2,4	120	20	10	26,40	11,90

- Leds 18 x 1500MCD 110°
- Leds 24 x 1500MCD 110°
- 220-240V / 50-60Hz.
- Batería. 2 x 4V 0,9Ah recargable.
- Autonomía: 5 HORAS
- Medidas; 245 x 75 x 45mm.
- Medidas: 325 x 75 x 45mm.

#### Luces de emergencia LED

43710	1	60		20	29,40	12,90
43712	2	150		20	39,40	16,90
43714	3,7	300		20	54,30	23,90

- Diseñada según norma. UNE EN 60598-2-22, y UNE-EN 60598-1, 62031 y 62384
- Grado de protección IP44 - IK 04
- Grado de protección II.
- Led indicador de presencia de red y carga de batería
- Batería de NI-Cd estanca, de alta temperatura
- Medidas: 255X89X37

#### Útil para empotrar serie Led

43720				10	6,40	2,99
-------	--	--	--	----	------	------

Medida empotrar: 278X115X36





Código	Color		Precio
Flexo estudio Md-Capri lámpara PL G23 11W			
HL069G	Gris	6	28,60
HL069B	Blanco	6	28,60
HL069N	Negro	6	28,60

- Lámpara incluida.
- Sobremesa o fijado con accesorio.



**oferta**  
**13,95€**

Flexo estudio 220V E27 -máx. 60W

HL050B	Blanco	12	14,80
HL050N	Negro	12	14,80
HL050R	Rojo	12	14,80

- Medidas: Campana 120mm.  
Altura 350mm.  
Base 130 mm.



**oferta**  
**6,95€**

Flexo estudio Md-Tango  
Lámpara estándar E27 máx..60W

44192	Blanco	6	25,90
HL074R	Rojo	6	25,90

**Lámpara no incluida.**



**oferta**  
**11,95€**



Código	Color		Precio
Flexo estudio con pinza			
HL067B	Blanco	12	15,50
HL067N	Negro	12	15,50
HL067R	Rojo	12	15,50

- 220 - 240V
- E27
- MAX. 60W
- Medidas: 300X120.

**oferta**  
**6,95€**



Código	Color		Precio
Flexo estudio			
4416021	Surtidos	8	26,50

- 220 - 240V
- E14
- MAX. 40W
- 1,2 mts de cable
- Medidas: 430X150.



**oferta**  
**11,95€**



Código	Color		Precio
Flexo lectura 8 led			
04002910	Plata	4	7,50

- Funciona con 3 baterías R03 incluidas.



**oferta**  
**3,50€**



Detalle Reloj

**5W LED**

25,90€



39,70€

**LUPA**

23,80€

Código	Color		Precio
Flexo estudio <b>LED 5W</b> con reloj			
44203	Azul	12	<b>53,60</b>
44204	Amarillo	12	<b>53,60</b>
44205	Rosa	12	<b>53,60</b>

- 220 - 240V / 50-60 Hz.  
- 5w - 300 lm. 4600K

- Control de funcionamiento  
( 3 funciones: 100% -50% - off )  
- Totalmente articulado, cabezal giratorio  
- Reloj con funcionamiento a baterias con boton de extraccion  
- Medidas: 400X300.

Flexo estudio <b>LED 10W</b>			
44206	Blanco	6	<b>82,10</b>
44207	Negro	6	<b>82,10</b>
44208	Plata	6	<b>82,10</b>

- 220 - 240V / 50-60 Hz.  
- 10w - 600 lm.  
- Control de funcionamiento  
- 3 tonos de luz diferentes  
(2700-4600-6400K)  
- Dimable  
- Totalmente articulado, cabezal giratorio  
- Medidas: 500X360.  
- Incluye gancho de sujecion para fijar en la mesa

Flexo estudio <b>LED 5W</b> con lupa			
44210	Blanco	12	<b>49,20</b>
44211	Negro	12	<b>49,20</b>
44212	Rojo	12	<b>49,20</b>

- 220 - 240V / 50-60 Hz.  
- 5w - 300 lm. 4600K  
- Control de funcionamiento tocando la base  
( 3 funciones: 100% -50% - off )  
- Totalmente articulado, cabezal giratorio  
- Medidas: 420X330.



Código	Modelo		Precio €
Portátil goma metal máx.60W			
44974	5 mts.	6/24	11,90
44976	10 mts.	6/24	16,80

- Cable manguera H-05 VV-F de 2X1 mm<sup>2</sup>.
- Fabricadas bajo norma UNE EN60598-2-8.



Código	Modelo		Precio €
Portátil goma metal máx.100W			
44953	5 mts.	6	15,80

- Cable manguera H-05 VV-F de 2X0,75 mm<sup>2</sup>.
- Fabricadas bajo norma UNE EN60598-2-8.



Código	Modelo		Precio €
Portátil goma metal máx.200W			
44959	5 mts.	6	19,60
44958	10 mts.	6	26,90

- Cable manguera H-05 VV-F de 2X0,75 mm<sup>2</sup>.
- Fabricadas bajo norma UNE EN60598-2-8.





Imanes



Código	Modelo		Precio €
Portátil 60 LED			
44963	60 leds	6	34,60

- Recargable portátil .
- Con transformador 110 / 220V a 12V.
- Clavija directa a mechero del coche.
- Tiempo de carga 3 horas.
- Autonomía de 5-6 horas.

**15,90€**



Portátil tubo 8W

44970	tubo	6	9,90
-------	------	---	------

- Cable de 5 mts. 12V

**4,50€**

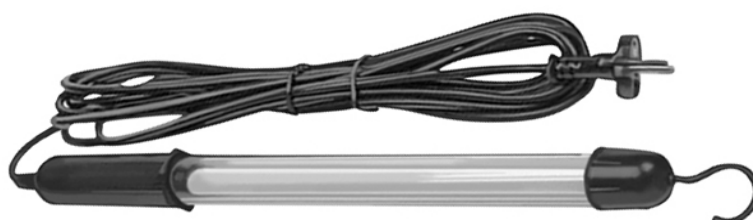

Portátil tubo 8W

44961	tubo	6	13,60
-------	------	---	-------

- Cable de 5 mts. 230V





6,90€

Código	Modelo		Precio €
--------	--------	---	----------

Pica jardín

4560690	una	10	14,80
---------	-----	----	-------

- Cable H05RN-F 2X1 2 M.



Pica jardín

45082	una	10	12,90
-------	-----	----	-------

- Cable 1'8 MTS.E27.



4,50€

Pica jardín con dos bases schucko 16A 250V

45026	1,5 mts.	6	9,90
-------	----------	---	------

- Cable de H07RN-F 3G 1,5mm.

- Máx. 3.500W.

VDE





Código	Modelo		Precio tarifa
Appliques halógenos G9 40W 220-240V 50Hz.			
HL743	1 luz	48	<b>13,40</b>

- Color cromo mate.
- Lámpara dicroica G9 40W ( incluida ).
- Medida base 70mm.



Appliques halógenos G9 40W 220-240V 50Hz.			
HL744	2 luces	24	<b>28,60</b>

- Color cromo mate.
- Lámpara dicroica G9 40W ( incluida ).
- Medida largo 275mm.



Appliques halógenos G9 40W 220-240V 50Hz.			
HL745	3 luces	20	<b>42,80</b>

- Color cromo mate.
- Lámpara dicroica G9 40W ( incluida ).
- Medida largo 445mm.



Appliques halógenos G9 40W 220-240V 50Hz.			
HL747	3 luces	24	<b>37,20</b>

- Color cromo mate.
- Lámpara dicroica G9 40W ( incluida ).
- Medida largo 180mm.



Código	Lumenes		Precio tarifa	Precio Oferta
Aplique COB LED 4W 220-240V 50Hz.				
HL7181L	260	48	39,20	15,90

- Color cromo.
- Luz: 3.000°K.
- IP20.

**1 LED = 4W**

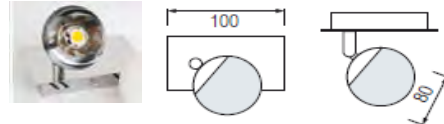

Apliques COB LED 2X4W 220-240V 50Hz.

HL7182L	520	24	69,40	29,90
---------	-----	----	-------	-------

- Color cromo.
- Luz: 3.000°K.
- IP20.

**2 LED = 8W**

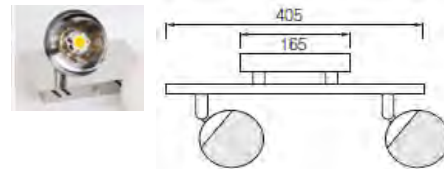

Apliques COB LED 3X4W 220-240V 50Hz.

HL7183L	780	20	99,80	39,90
---------	-----	----	-------	-------

- Color cromo.
- Luz: 3.000°K.
- IP20.

**3 LED = 12W**

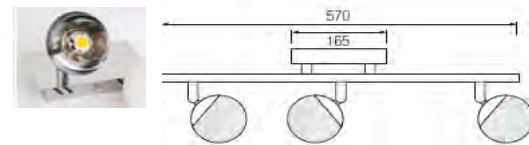

**LED  
COB**



# Lámpara pendular LED 12W

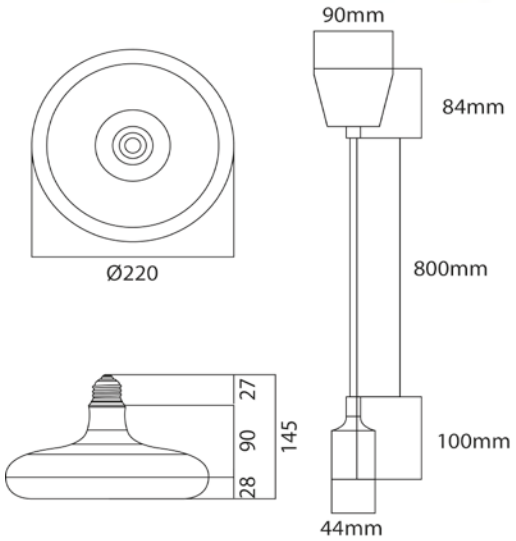



Código	Color	Lumens		Precio € Tarifa	Precio € Neto
Lámpara pendular LED 12W E27 6400K					
42740	Blanca	850	10	36,90	16,90
42741	Negra	850	10	36,90	16,90
42742	Roja	850	10	36,90	16,90
42743	Azul	850	10	36,90	16,90



Foto	Código	Medidas	Color		Precio € tarifa
<b>Aros en aluminio para lamparas 50mm.</b>					
	47201	80X25	Blanco	100	3,80
	47202	80X25	Cromo mate	100	4,50
	47210	85X25	Cromo	100	4,70
	47211	85X25	Cromo mate	100	4,70
	47212	85X25	Antiq. Cobre	100	4,70
	47220	85X25	Cromo	100	4,70
	47221	85X25	Cromo mate	100	4,70
	47222	85X25	Antiq. Cobre	100	4,70

**Medidas de corte 70 mm.**



Código	Color	Medida		Precio €	Precio € Oferta
Downlight <b>aluminio</b> para 2X26W					
47840	Blanco	230 mm.	6	<b>28,40</b>	<b>3,90</b>
47845	Níquel	230 mm.	6	<b>32,40</b>	<b>3,90</b>

**Lámparas incluidas.**



Downlights redondo en **aluminio** inyectado

47899	Níquel	165 mm.	6	<b>29,80</b>	<b>3,90</b>
-------	--------	---------	---	--------------	-------------

- Con balastro electrónico digital.
- Para 2 lámparas PL-G24Q3 de 13W.

**Lámparas incluidas.**



Downlights aluminio para 2 X E27

47430	Blanco	158X90 mm	6	<b>15,40</b>	<b>1,90</b>
-------	--------	-----------	---	--------------	-------------

- Usan 2 lámparas bajo consumo E27 (no incluidas).



Downlights para 2 G24 2 pin (Especial lám.leds)

47885	Blanco	225 mm.	6	<b>16,40</b>	<b>1,90</b>
-------	--------	---------	---	--------------	-------------

- Medida exterior ancho 225mm. Altura 90mm.
- Usa 2 lámparas LEDS G24 2 pins (no incluidas).



**5W**



**5W**



**5W**

Código	Color	Luz	Lumen		Precio €
Aro led 5W con equipo 220-230V - 50Hz.					
46015	Blanco	2700K	354	10/50	18,90
46016	Blanco	6500K	354	10/50	18,90
46017	Niquel	2700K	354	10/50	18,90
46018	Niquel	6500K	354	10/50	18,90

- Medida exterior ancho 90mm.
- Altura 60mm.
- Medidas de corte: 75mm.

**COB  
LED**

CUERPO DE ALUMINIO



NETO CAJAS COMPLETAS

Aro led 5W con equipo 220-230V - 50Hz.

46010	Blanco	2700K	354	10/50	18,90
46011	Blanco	6500K	354	10/50	18,90
46012	Niquel	2700K	354	10/50	18,90
46013	Niquel	6500K	354	10/50	18,90

- Medida exterior ancho 90mm.
- Altura 60mm.
- Medidas de corte: 75mm.

**COB  
LED**

CUERPO DE ALUMINIO



NETO CAJAS COMPLETAS

Aro led ECO 5W con equipo 220-230V - 50Hz.

46020	Blanco	2700K	325	10/50	13,90
46021	Blanco	6500K	325	10/50	13,90
46022	Niquel	2700K	325	10/50	13,90
46023	Niquel	6500K	325	10/50	13,90

- Medida exterior ancho 83mm.
- Altura 40mm.
- Medidas de corte: 70mm.

**COB  
LED**





CUERPO DE HIERRO



NETO CAJAS COMPLETAS





Código		Medidas	Luz	Color	Lumen	watios		Precio € tarifa	Oferta Cajas comple.
<b>Downlight aluminio</b>		220-240V 50-60Hz.				Grados apertura 120°			
46055		150X50	6400K	Blanco	550	<b>10W</b>	20	18,40	7,90
46057		150X50	6400K	Cromo Mt.	550		20	19,40	7,90
46059		180X60	6400K	Blanco	650	<b>15W</b>	20	27,60	9,90
46061		180X60	6400K	Cromo Mt.	650		20	28,60	9,90
46062		220X70	3000K	Blanco	1312	<b>25W</b>	10	35,20	14,90
46063		220X70	6400K	Blanco	1312		10	35,20	14,90
46065		220X70	6400K	Cromo Mt.	1312		10	36,20	14,90

- Marca de LED: ETI
- Temperatura de trabajo: -20 + 50.
- Protección clase II. IP20
- Compatibilidad electromagnética WEEE Aprobado.



# PANEL LED EXTRAFINO

Los paneles LED proporcionan una proyección uniforme de la luz. Ideal para uso en techos de hogares, despachos locales comerciales y diversas estancias.

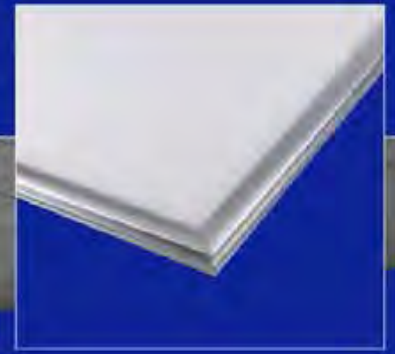

Extrafinos,  
brillantes  
y modernos



Código	Color	Lumen		Precio €
<b>Panel LED Extrafino BLANCO</b>				
47973	6000K	1280	40	14,20
<ul style="list-style-type: none"> <li>- Cuerpo aluminio inyectado.</li> <li>- 220-240V - IP20.</li> <li>- Medidas: 225mm. diamet. total, altura 15mm.</li> <li>- Medidas de corte. 210mm.</li> </ul>				
<b>Panel LED SUPERFICIE BLANCO</b>				
47976	6000K	1280	20	31,60
<ul style="list-style-type: none"> <li>- Medidas: 225mm. diamet. total, altura 37mm.</li> </ul>				
<b>Panel LED Extrafino NIQUEL</b>				
47975	6000K	1280	40	21,80
<ul style="list-style-type: none"> <li>- Cuerpo aluminio inyectado.</li> <li>- 220-240V - IP20.</li> <li>- Medidas: 225mm. diamet. total, altura 15mm.</li> <li>- Medidas de corte. 200mm.</li> </ul>				
<b>Panel LED Extrafino BLANCO</b>				
47964	4000K	1550	20	17,60
47963	6000K	1650	20	17,60
<ul style="list-style-type: none"> <li>- Cuerpo aluminio inyectado.</li> <li>- 220-240V - IP20.</li> <li>- Medidas: 223mm. diamet. total, altura 15mm.</li> <li>- Medidas de corte. 210mm.</li> </ul>				
<b>Panel LED Ultra slim BLANCO</b>				
47977	4000K	2600	10	43,80
47978	6000K	2600	10	43,80
<ul style="list-style-type: none"> <li>- Cuerpo aluminio inyectado.</li> <li>- 220-240V - IP20.</li> <li>- Medidas: 220mm. diamet. total, altura 10mm.</li> <li>- Medidas de corte. 185mm.</li> </ul>				

# PANEL LED EXTRAFINO

Los paneles LED proporcionan una proyección uniforme de la luz. Ideal para uso en techos de hogares, despachos locales comerciales y diversas estancias.

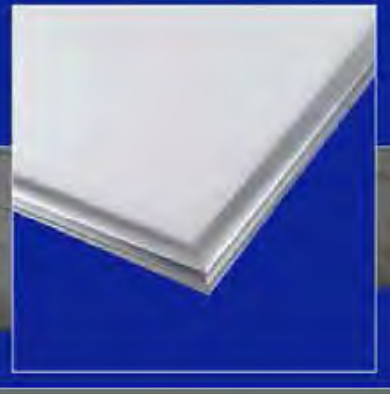

Extrafinos,  
brillantes  
y modernos



36W

**NUEVO**



52W



4 Uds.

COD. 4798S



4 Uds.

COD. 4798M



SOLO PARA PANELES DE 52W COD - 47984 Y 47985

Código	Color	Lumen		Precio €
--------	-------	-------	---	----------

Panel LED  
PARA TECHO ASTRONG 36W

47987	6000K	2700	5	66,00
-------	-------	------	---	-------

- Cuerpo aluminio
- 220-240V - IP20.
- Medidas: 595X595X10mm.

Panel LED  
PARA TECHO ASTRONG O SUPERFIE 52W

47984	4000K	4250	5	118,20
-------	-------	------	---	--------

47985	6000K	4500	5	118,20
-------	-------	------	---	--------

- Cuerpo aluminio inyectado.
- 220-240V - IP20.
- Medidas: 595X595X10mm.

4798S	S.superf.		1	6,90
-------	-----------	--	---	------

4798M	Empotrar		1	6,90
-------	----------	--	---	------

CON LOS SOPORTES  
ES POSIBLE REALIZAR UNA  
INSTALACIÓN  
DE SUPERFICIE



Código	Medidas	Medidas			Lumen	wattios		Precio € tarifa
		Medidas	corte	Luz				
<b>Downlight opal de Led</b>		220-240V 50-60Hz.			Grados apertura 120°			
46167	90X25	70	3000K	110	<b>3W</b>	40	4,48	
46168	90X25	70	4200K	110		40	4,48	
46169	90X25	70	6400K	110		40	4,48	
46170	120X25	105	3000K	270	<b>6W</b>	40	7,44	
46171	120X25	105	4200K	270		40	7,44	
46172	120X25	105	6400K	270		40	7,44	
46173	150X25	135	3000K	540	<b>9W</b>	40	8,63	
46174	150X25	135	4200K	540		40	8,63	
46175	150X25	135	6400K	540		40	8,63	
46176	170X25	155	3000K	660	<b>12W</b>	20	10,98	
46177	170X25	155	4200K	660		20	10,98	
46178	170X25	155	6400K	660		20	10,98	
46179	195X25	170	3000K	900	<b>15W</b>	20	12,24	
46180	195X25	170	4200K	900		20	12,24	
46181	195X25	170	6400K	900		20	12,24	
46182	225X25	205	3000K	1170	<b>18W</b>	20	13,59	
46183	225X25	205	4200K	1170		20	13,59	
46184	225X25	205	6400K	1170		20	13,59	
46186	300X25	285	4200K	1632	<b>24W</b>	10	29,55	
46187	300X25	285	6400K	1632		10	29,55	
<b>Pantallas Led</b>		220-240V 50-60Hz.			Grados apertura 120°			
46201	595x595x10,5	285	3000K	1800	<b>32W</b>	10	50,43	
46202	595x595x10,5	285	6400K	2000		10	50,43	







- Tipo de LED SMD, 40x14. Marca de LED: ETI
- Temperatura de trabajo: -20 + 40.
- Protección clase II. IP20
- Compatibilidad electromagnética WEEE Aprobado.
- EMC Aprobado.













Precio €  
tarifa

Código		Medidas	Luz	Lumen	watios		Precio € tarifa
<b>Downlight Led opal</b>		220-240V 50-60Hz.			Grados apertura 120°		
46150		180X40	3000K	840	<b>12W</b>	20	19,74
46151		180X40	4200K	840		20	19,74
46152		180X40	6400K	840		20	19,74
46153		225X40	3000K	1300	<b>18W</b>	20	22,35
46154		225X40	4200K	1300		20	22,35
46155		225X40	6400K	1300		20	22,35
46156		300X40	3000K	1960	<b>28W</b>	20	44,32
46157		300X40	4200K	1960		20	44,32
46158		300X40	6400K	1960		20	44,32
46159		180X40	3000K	840	<b>12W</b>	20	19,74
46160		180X40	4200K	840		20	19,74
46161		180X40	6400K	840		20	19,74
46162		225X40	3000K	1300	<b>18W</b>	20	22,35
46163		225X40	4200K	1300		20	22,35
46164		225X40	6400K	1300		20	22,35
46165		300X40	3000K	1960	<b>28W</b>	20	44,32
46166		300X40	4200K	1960		20	44,32
46188		300X40	6400K	1960		20	44,32

- Marca de LED: ETI
- Temperatura de trabajo: -20 + 50.
- Protección clase II. IP20
- Compatibilidad electromagnética WEEE Aprobado.







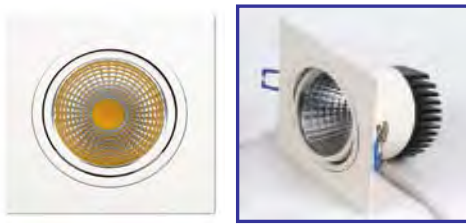

Código		Medidas	Luz	Lumen	watios		Precio € tarifa
<b>Downlight Led opal SUPERFICIE</b>			220-240V 50-60Hz.		Grados apertura 120°		
				2240	<b>32W</b>	5	49,50
46206		400X40	4200K	2240		5	49,50
46207		400X40	6400K	2240		5	49,50
					<b>40W</b>		
46209		500X40	4200K	2800		5	78,20
46210		500X40	6400K	2800		5	78,20
					<b>48W</b>		
46212		600X40	4200K	3360		5	92,40
					<b>24W</b>		
46224		300X600X40	4200K	1680		10	53,80
					<b>36W</b>		
46227		300X1200X40	4200K	2520		5	94,60

- Marca de LED: ETI
- Temperatura de trabajo: -20 + 50.
- Protección clase II. IP20
- Compatibilidad electromagnética WEEE Aprobado.



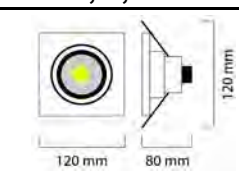
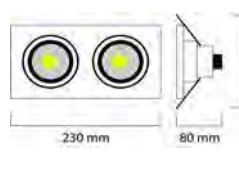
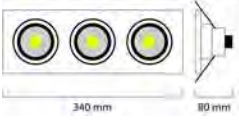

Código		Medidas	Luz		Lumen	watios		Precio € tarifa
<b>Apliques led de 1, 2, ó 3 elementos</b>			220-240V 50-60Hz.		Grados apertura 120°			
HL6711LC		120X80	3000K	Blanco	539	<b>10W</b>	10	<b>36,90</b>
HL6711L		120X80	6400K	Blanco	539		10	<b>36,90</b>
HL6712L		230X120X80	6400K	Blanco	2X539	<b>20W</b>	10	<b>68,40</b>
HL6713LC		340X120X80	3000K	Blanco	3X539		<b>30W</b>	10
HL6713L		340X120X80	6400K	Blanco	3X539	10		<b>96,60</b>
46070		235X100	6400K	Blanco	1447	<b>30W</b>	20	<b>77,40</b>

- Marca de LED: ETI
- Temperatura de trabajo: -20 + 50.
- Protección clase II. IP20
- Compatibilidad electromagnética WEEE Aprobado.





# PROYECTORES COB LED

IP65





**SMD  
LED**

# PROYECTORES SMD LED

**IP65**



# PROYECTORES SMD LED **ULTRASLIM**



Código	Wattios	Lumenes		Precio tarifa
Proyector SMD led ultra slim 6000K IP65				
49657	22W	1690	6	<b>34,90</b>

Medidas: 190x22x145mm



Proyector SMD led ultra slim 6000K IP65				
49659	32W	2540	6	<b>47,90</b>

Medidas: 220x22x175mm



Proyector SMD led ultra slim 6000K IP65				
49661	52W	4250	4	<b>65,90</b>

Medidas: 220x22x185mm



**ultraSLIM**  
GROSOR 2,3CM



**10W**

**OFERTA  
5,50€**



**20W**

**OFERTA  
9,50€**



**30W**

**OFERTA  
12,50€**

**Proyector SMD LED 6.000°K IP65**  
- Lumens: 700  
- Medidas: 135X115X39mm.

**Proyector SMD LED 6.000°K IP65**  
- Lumens: 1400  
- Medidas: 182x141x47 mm.

**Proyector SMD LED 6.000°K IP65**  
- Lumens: 2000  
- Medidas: 225x185x54 mm.

Código		P.V.
49651	50	11,95

Código		P.V.
49652	30	21,20

Código		P.V.
49653	20	27,50



**50W**

**OFERTA  
19,90€**





**100W**

**OFERTA  
35,90€**

**Proyector SMD LED 6.000°K IP65**  
- Lumens: 3400  
- Medidas: 285x232x62 mm.

**Proyector SMD LED 6.000°K IP65**  
- Lumens: 6900  
- Medidas: 337x289x62 mm.

Código		P.V.
49654	15	43,60

Código		P.V.
49655	5	78,90



**OFERTA  
49,90€**

**150W**

**Proyector SMD LED 6.000°K IP65**  
- Lumens: 10900  
- Medidas: 337X289X62 mm.

Código		P.V.
49656	4	110,00

## PROYECTORES COB LED



- ✓ Interior/Exterior.
- ✓ Larga duración.
- ✓ Luz inalterable en el tiempo.
- ✓ Alto rendimiento lumínico.
- ✓ Bajo consumo eléctrico.
- ✓ Baja emisión de calor.
- ✓ No emite radiación IR ni UV.

### ESPECIFICACIONES TÉCNICAS

Toma de corriente	AC85-277V
Temperatura de color	4.000° K
Cuerpo	Aluminio
I.P.	65
Horas	20.000
CRI	>80



**OFERTA  
6,50€**

Código	Ud. venta	Precio
49645	20	14,90

49645	20	14,90
-------	----	-------

10 W  
650 Lumen  
Luz fría: 4.000 °K



**OFERTA  
11,90€**

Código	Ud. venta	Precio
49646	12	29,90

49646	12	29,90
-------	----	-------

20 W  
1.300 Lumen  
Luz fría: 4.000 °K



**OFERTA  
15,90€**

Código	Ud. venta	Precio
49647	8	44,20

49647	8	44,20
-------	---	-------

30 W  
1.850 Lumen  
Luz fría: 4.000 °K





**OFERTA**  
**22,90€**

# PROYECTORES LED

**Código Ud. venta Precio**

49648	4	59,60
-------	---	-------

50 W  
3.400 Lumen  
Luz fría: 4.000 °K



**OFERTA**  
**45,90€**

**Código Ud. venta Precio**

49635	4	110,40
-------	---	--------

100 W  
6.900 Lumen  
Luz fría: 4.000 °K



**OFERTA**  
**19,90€**

**C/SENSOR  
CREPUSCULAR Y  
MOVIMIENTO**

**Código Ud. venta Precio**

49615	4	64,90
-------	---	-------

20 W  
1.300 Lumen  
Luz fría: 4.000 °K

Oferta  
13,90€ **20W**

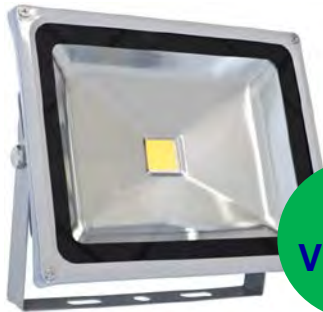

LED  
VERDE

### ESPECIAL GARDEN

Proyector SMD LED 6.500°K IP65  
- Lumens: 1400

Código	P.V.
49617	29,90

Oferta  
19,90€ **30W**



Proyector SMD LED 6000°K IP65  
- Lumens: 1850  
- 3 metros de manguera RN 3X1

Código	P.V.
49640	43,20

Oferta  
29,90€ **30W**

CON  
SOPORTE



Proyector SMD LED 6000°K IP65  
- Lumens: 1850  
- 3 metros de manguera RN 3X1

Código	P.V.
49642	49,60

## RECARGABLES

duración de batería aprox. 8 hr.

Oferta  
32,90€ **50W**



CON  
SOPORTE

Proyector SMD LED 6000°K IP65  
- Lumens: 3,400  
- 3 metros de manguera RN 3X1

Código	P.V.
49643	69,40

Oferta  
47,90€ **20W**



Proyector COB LED 4000°K IP65  
- 20W Lumens: 1300  
- Cargador a 220V y a 12V toma de encendedor  
- Estribo de fijación

Código	P.V.
49637	106,00

Oferta  
75,90€ **30W**



Proyector COB LED 4000°K IP65  
- 30W Lumens: 2100  
- Cargador a 220V y a 12V toma de encendedor  
- Estribo de fijación

Código	P.V.
49639	162,00



**10W**



**20W**





**30W**

**Proyector SMD LED 6.500°K IP65**  
- Lumens: 500  
- Medidas: 150X126X35mm.

**Proyector SMD LED 6.500°K IP65**  
- Lumens: 1000  
- Medidas: 182x151x36 mm.

**Proyector SMD LED 6.500°K IP65**  
- Lumens: 1.500  
- Medidas: 229x182x37 mm.

Código		P.V.
49750	10	13,90

Código		P.V.
49751	5	24,40

Código		P.V.
49752	5	29,90



**50W**



**100W**





**200W**

**Proyector SMD LED 6.500°K IP65**  
- Lumens: 2.500  
- Medidas: 374x118x38,5 mm.

**Proyector SMD LED 6.500°K IP65**  
- Lumens: 5000  
- Medidas: 395x308x70 mm.

**Proyector SMD LED 6.500°K IP65**  
- Lumens: 9750  
- Medidas: 480X430X102 mm.

Código		P.V.
49753	5	43,30

Código		P.V.
49754	5	97,60

Código		P.V.
49755	5	263,00



**70W**



**100W**





**150W**

**Proyector SMD LED 6.500°K IP65**  
- Lumens: 5600  
- Medidas: 240X215X85

**Proyector SMD LED 6.500°K IP65**  
- Lumens: 8000  
- Medidas: 290X230X90

**Proyector SMD LED 6.500°K IP65**  
- Lumens: 12000  
- Medidas: 370X290X90 mm.

Código		P.V.
49766	5	109,70

Código		P.V.
49767	5	198,60

Código		P.V.
49768	5	318,40

**CON SENSOR**

**10W**



**CON SENSOR**

**20W**



**CON SENSOR**

**30W**



**Proyector SMD LED 6.400°K IP65**  
 - Lumens: 500  
 - Medidas: 150X186X62mm.

**Proyector SMD LED 6.400°K IP65**  
 - Lumens: 1000  
 - Medidas: 182x208X62mm.

**Proyector SMD LED 6.400°K IP65**  
 - Lumens: 1500  
 - Medidas: 225X240X62mm.

Código		P.V.
49758	10	29,20

Código		P.V.
49759	5	39,20

Código		P.V.
49760	5	46,20

**CON SENSOR**

**50W**



**CON SENSOR**

**100W**



**10W**



**OFERTA**  
**19,90€**

**Proyector SMD LED 6.400°K IP65**  
 - Lumens: 2500  
 - Medidas: 274X274X63mm.

**Proyector SMD LED 6.400°K IP65**  
 - Lumens: 5000  
 - Medidas: 395X365X110mm.

- 220-240V - 50-60 Hz.  
 - IP 65.  
 - Luz 6500K  
 - 10W. 520 Lumenes  
 - Medidas: 150X170X50 mm.

Código		P.V.
49761	5	59,30

Código		P.V.
49762	5	119,00

Código		P.V.
HL171L	5	59,90

# SERIE INDUSTRIAL Md. Leopar



**20W**



**30W**



**50W**

### Proyector SMD LED IP65

- Lumens: 1700
- Medidas: 157X180mm.

### Proyector SMD LED IP65

- Lumens: 2550
- Medidas: 171x195mm.

### Proyector SMD LED IP65

- Lumens: 4250
- Medidas: 202x243mm.

Código		P.V.
49782 4200K	24	32,00
49783 6500K	24	32,00

Código		P.V.
49784 4200K	20	42,00
49785 6500K	20	42,00

Código		P.V.
49786 4200K	10	58,00
49787 6500K	10	58,00



**100W**



**150W**



**200W**

### Proyector SMD LED IP65

- Lumens: 8500
- Medidas: 253x280mm.

### Proyector SMD LED IP65

- Lumens: 12750
- Medidas: 310x345mm.

### Proyector SMD LED IP65

- Lumens: 17000
- Medidas: 310x345 mm.

Código		P.V.
49788 4200K	5	106,00
49789 6500K	5	106,00

Código		P.V.
49790 4200K	5	148,00
49791 6500K	5	148,00

Código		P.V.
49792 4200K	5	192,00
49793 6500K	5	192,00

# SERIE INDUSTRIAL Md. Panter



**50W**

**Proyector COB LED IP65 6400K**  
 - Lumens: 3750  
 - Medidas: 245X297mm.

Código		P.V.
49771	6	59,00



**100W**

**Proyector COB LED IP65 6400K**  
 - Lumens: 7500  
 - Medidas: 246x324mm.

Código		P.V.
49773	6	87,00



**150W**

**Proyector COB LED IP65 6400K**  
 - Lumens: 11250  
 - Medidas: 315x418mm.

Código		P.V.
49775	1	162,00

**Proyector COB LED IP65 6400K**  
 - Lumens: 15000  
 - Medidas: 314X418mm.

Código		P.V.
49777	1	176,00

**Proyector COB LED IP65 6400K**  
 - Lumens: 22500  
 - Medidas: 345x525mm.

Código		P.V.
49779	1	263,00

**Proyector COB LED IP65 6400K**  
 - Lumens: 30000  
 - Medidas: 355x625 mm.

Código		P.V.
49781	1	340,00



**200W**

**300W**

**400W**



**Oferta**  
**2,45€**



**Oferta**  
**3,90€**



**Oferta**  
**5,90€**



**Oferta**  
**2,95€**

**Precio  
tarifa**

Código	Wattios	Color		
Proyectores halógenos 120W con lámpara.				
49503	120W	negro	6	<b>6,90</b>
49504	120W	blanco	6	<b>6,90</b>

**Lámpara incluida.**



para 24  
**1,99€**



Proyectores halógenos 400W con lámpara.

49514	400W	blanco	6	<b>8,90</b>
-------	------	--------	---	-------------

- Carcasa anticorrosión.
- Protección clase HI, impermeable AIP X4.
- Portalámparas R7s.



Proyectores bajo consumo 20W

49702	20W	negro	20	<b>17,90</b>
-------	-----	-------	----	--------------

- Carcasa anticorrosión.
- Protección clase HI, impermeable AIP X4.
- Portalámparas R7s.
- Medidas: 185x140.

**Lámpara incluida.**

**POR LA COMPRA DE UNA CAJA DE  
PROYECTORES OBSEQUIO DE 2 CAJAS DE  
LÁMPARAS COD-41295**

Proyectores bajo consumo 20W

41295	20W	1200 lm	10	<b>12,60</b>
-------	-----	---------	----	--------------



**CON  
CABLE**

**Neto  
7,90€**



**Neto  
7,90€**



**CON  
CABLE**

**Neto  
9,90€**



**Neto  
9,90€**

Código	Wattios	Color		Precio tarifa
Proyector halógeno con sensor de mov. 180° e interruptor crepuscular				
49552	120W	Blanco	6	<b>32,40</b>

- Con lámpara y manguera de 3x1.
- H05RN - F. Goma negra 5 mts.
- Portalámparas R7s.

Presentación en caja a color.

49546	120W	Blanco	6	<b>22,80</b>
49547	120W	Negro	6	<b>22,80</b>

- Sin cable.

Presentación en caja a color.

Proyector halógeno con sensor de mov.180°  
e interruptor crepuscular

49557	400W	Blanco	6	<b>36,80</b>
-------	------	--------	---	--------------

- Con lámpara y manguera de 3x1.
- H05RN - F. Goma negra 5 mts.
- Portalámparas R7s.

Presentación en caja a color.

Proyector halógeno con sensor de mov. 180°  
e interruptor crepuscular

49548	400W	Blanco	6	<b>26,40</b>
49549	400W	Negro	6	<b>26,40</b>

- Sin cable.

Presentación en caja a color.





**Neto  
1,99€**

Código	Wattios	Color		Precio tarifa
Proyector bajo consumo cuerpo de aluminio				
77018	100W	Negro	4	17,40 €

- Conexión directa a red 230V 50Hz.
- Portalamparas E27
- Medida exteriores: 247X155.
- Medida interiores: 175X120.
- Medida máx. Lámpara 160X60.
- Lámpara no incluida.

**Máx.100W  
1xE27**

**Lámpara no incluida**



**Neto  
2,99€**

Código	Wattios	Color		Precio tarifa
Proyector bajo consumo cuerpo de aluminio				
77021	200	Negro	4	22,60 €

- Conexión directa a red 230V 50Hz.
- Portalamparas E27
- Medida exteriores: 340X220.
- Medida interiores: 260X180.
- Medida máx. Lámpara 250X100.
- Lámpara no incluida.

**Máx.200W  
1xE27**

**Lámpara no incluida**



**Neto  
28,90€**



**Neto  
6,90€**



**Neto  
17,50€**



**Neto  
18,90€**

Código	Modelo		Precio tarifa
<b>Set Proyectoros halógenos 2x400w con trípode</b>			
49586	2 Cabezas	2	<b>64,60</b>

- Con 5 mts de cable goma.
- Altura: 1,60 mt.

**Soporte proyector suelo**

49592		1	<b>15,20</b>
-------	--	---	--------------

- Con 1,50 mts de cable goma.
- Medidas: 170x270 mm.

**Trípode extensible**

49590	1 Cabeza	1	<b>41,40</b>
-------	----------	---	--------------

- Con 1,80 mts de cable goma.
- Altura: 1,60 mt.

**Trípode extensible**

49591	2 Cabezas	1	<b>44,80</b>
-------	-----------	---	--------------

- Con 1,80 mts de cable goma.
- Altura: 1,60 mt.



**Neto  
25,90€**



**Neto  
73,90€**

Código	Color	W		Precio €
Proyector de halogenuro metálico, conexión directa.				
49931	Negro	70	6	64,20

- Medidas: 350X230X87mm.
- Usa 1 lámpara halogenuro metálico, R7 (incl).
- Cuerpo de aluminio.
- Para interior y exterior.
- Lumens para la de 70W 5500lm.
- Lumens para la de 150W 12000lm.

#### Lámparas incluidas.

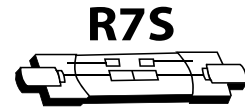

Código	Color	W		Precio €
Proyector de halogenuro metálico, conexión directa.				
49924	Negro	250	6	178,00
49925	Negro	400	6	178,00

- Medidas: 485X410X140mm.
- Usa 1 lámpara halogenuro metálico, E40 (incl).
- Cuerpo de aluminio barnizado color negro.
- Vidrio de seguridad templado transparente.
- Lira de acero.
- Cierre mediante clips muelle inoxidables.
- Junta estanca resistente a altas temperaturas.
- Lumens para la de 250W 22500lm.
- Lumens para la de 400W 36000lm.

#### Lámparas incluidas.

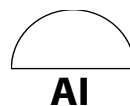



**Neto  
49€**

Código	W	Color		Precio
Proyector bajo consumo 3x36w				
49711	3x36	negro	1	132,00 €

- 220-250 V.
- 108W ( 3x36W), 50-60 Hz.
- Carcasa Policarbonato.
- Estanqueidad IP44.
- 8.200 Lumens.
- Cable de 5 mts. H07RN-F 3G1,5.
- Con 3 bases shucko 230V 16A.
- Medidas: 500x290x110 mm.

**Lámparas incluidas.**



**Neto  
39€**

Código	W	Color		Precio
Proyector bajo consumo 3x24w				
49706	3X24	negro	1	112,00 €

- 220-250 V.
- 72W ( 3x24W), 50-60 Hz.
- Carcasa Policarbonato.
- Estanqueidad IP44.
- 5.900 Lumens.
- Cable de 5 mts. H07RN-F 3G1,5.
- Con 3 bases shucko 230V 16A.
- Medidas: 415x290x110 mm.

**Lámparas incluidas.**





**Neto**  
**19,90€**



**Neto**  
**49,90€**



**Neto**  
**79,00€**



Código	W	Color		Precio
Farola calle para lámpara bajo consumo E27				
HL190	60	Blanca	10	41,20

- Portalámparas E27. (No incluye lámpara).
- 220-240V - 50-60 Hz.
- Carcasa policarbonato.
- Estanteidad IP 65.
- Medidas 345x200x120 mm.

Código	W	Color		Precio
Farola calle SMD LED				
HL195L	26	Plata	2	146,00

- 220-240V - 50-60Hz.
- Cuerpo aluminio inyectado.
- Lámpara LED 12 SMD.
- Lúmenes: 2250.
- Medidas: 370 X 90mm.
- IP 65.

Código	W	Lumens		Precio
Campana led C.O.B. en Aluminio				
HL515L	50W	2990	1	236,00

- 220-240V - 50-60Hz.
- Cuerpo aluminio inyectado
- LED C.O.B. 50W
- Lúmenes: 2990
- Medidas: 440 X 900mm.
- Color 6400K - IP 20





**Neto  
56,90€**



**Neto  
72€**



**Neto  
165€**



**Neto  
215€**

Código	W	Color		Precio
Farola calle LED C.O.B. IP65				
49862	1X30	Plata	1	<b>166,60</b>

- 110-240V - 50-60Hz.
- Cuerpo aluminio inyectado
- Lámpara LED C.O.B. 4200K
- Lúmenes: 3150
- Medidas: 500X222X82mm.
- Medidas tubo 53mm.

49863	1X50	Plata	1	<b>218,00</b>
-------	------	-------	---	---------------

- 110-240V - 50-60Hz.
- Cuerpo aluminio inyectado
- Lámpara LED C.O.B. 4200K
- Lúmenes: 5250
- Medidas: 580X226X92mm.
- Medidas tubo 50mm.

49864	2X50	Plata	1	<b>360,00</b>
-------	------	-------	---	---------------

- 110-240V - 50-60Hz.
- Cuerpo aluminio inyectado
- Lámpara LED C.O.B. 4200K
- Lúmenes: 10500
- Medidas: 680X238X92mm.
- Medidas tubo 63mm.

49865	3X50	Plata	1	<b>460,00</b>
-------	------	-------	---	---------------

- 110-240V - 50-60Hz.
- Cuerpo aluminio inyectado
- Lámpara LED C.O.B. 4200K
- Lúmenes: 15750
- Medidas: 811X267X92mm.
- Medidas tubo 63mm.

Conforme a las normas CE.  
Utilización: patios, escaparates, monumentos,  
instalaciones deportivas, fachadas, etc.





Código	W	Lumens	Medidas		Precio
Campana en policarbonato inastillable					
HL501	300W		Transp.	5	34,80

- Lámpara máx. Bajo consumo 75W (no incluida).
- Portalámparas E27.
- Medidas: boca Ø 180mm.
- Largo total 90 cm.
- IP 20

**Neto**  
**15,90€**



Campana en policarbonato inastillable

HL510	300W		Transp.	5	55,60
-------	------	--	---------	---	-------

- Lámpara máx. Bajo consumo 65W (no incluida).
- Portalámparas E27.
- Medidas: boca Ø 335mm.
- Cadena hasta 1 metro.
- IP 20

**Neto**  
**25,90€**



Campana en policarbonato inastillable

HL513	300W		Transp.	5	79,20
-------	------	--	---------	---	-------

- Lámpara máx. Bajo consumo 80W (no incluida).
- Portalámparas E27.
- Medidas: boca Ø 413mm.
- Cadena hasta 1 metro.
- IP 20

**Neto**  
**36,90€**



Conforme a las normas CE.  
Utilización: patios, escaparates, monumentos,  
instalaciones deportivas, fachadas, etc.



**Neto  
84,90€**



**Neto  
64,90€**

Código	Color		Medida	Precio €
--------	-------	---	--------	----------

Farola aluminio 3 cabezas

49489	Negro	6	2100X500	188,40
-------	-------	---	----------	--------

- Portalámparas 3xE27.
- Máx. 3x60W.
- IP44.

Farola aluminio 1 cabeza

49490	Negro	6	2100X500	143,60
-------	-------	---	----------	--------

- Portalámparas 3xE27.
- Máx. 60W.
- IP44.







Código	Color		Medida	Precio €
<b>Farol aluminio colgar</b>				
49470	Blanco	6	250X165	<b>24,20</b>
49471	Negro	6	250X165	<b>24,20</b>
49472	Rojo Ox.	6	250X165	<b>24,20</b>
49415	Verde Ox.	6	310X200	<b>24,20</b>

**Netos**  
**10,90€**



Código	Color		Medida	Precio €
<b>Farol aluminio pared</b>				
49460	Blanco	6	300X165	<b>25,80</b>
49461	Negro	6	300X165	<b>25,80</b>
49462	Rojo Ox.	6	300X165	<b>25,80</b>

**Netos**  
**10,90€**

Código	Color		Medida	Precio €
<b>Farol aluminio sobremuro</b>				
49465	Blanco	4	400X200	<b>25,90</b>
49466	Negro	4	370X165	<b>25,90</b>
49467	Rojo Ox.	4	370X165	<b>25,90</b>
49416	Verde Ox.	4	400X200	<b>25,90</b>

**Todos presentados en caja color.**



**Netos**  
**11,90€**





Código	Color		Medida	Precio €
<b>Farol aluminio pared MD-TEXAS</b>				
49475	Blanco	6	380x145	<b>28,20</b>
49476	Negro	6	380x145	<b>28,20</b>
49477	Rojo Ox.	6	380x145	<b>28,20</b>
49322	Verde Ox.	6	430x170	<b>28,20</b>



**Netos  
11,90€**



**Farol aluminio colgar MD-TEXAS.**

49485	Blanco	12	320x145	<b>26,60</b>
49486	Negro	12	320x145	<b>26,60</b>
49487	Rojo Ox.	12	320x145	<b>26,60</b>

**Netos  
11,90€**



**Farol aluminio sobremuro MD-TEXAS**

49480	Blanco	6	430x145	<b>27,90</b>
49481	Negro	6	430x145	<b>27,90</b>



**Netos  
11,90€**



Código	Color		Medida	Precio €
--------	-------	---	--------	----------

Farol inoxidable pared

49450	Inox.	6	330X215	53,10
-------	-------	---	---------	-------

- Portalámparas E27.
- Máx. 60W.



Farol inoxidable colgar

49451	Inox.	6	850X198	50,60
-------	-------	---	---------	-------

- Portalámparas E27.
- Máx. 60W.



Farol inoxidable sobremuro

49452	Inox.	6	300X198	52,10
-------	-------	---	---------	-------

- Portalámparas E27.
- Máx. 60W.



Farol inoxidable pared

HL217	Inox.	6	310x280	56,20
-------	-------	---	---------	-------

- Portalámparas E27.
- Máx. 60W.
- IP44.

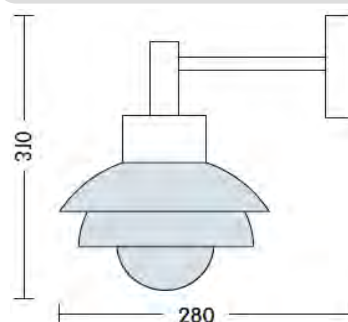

Homologadas:





Código	Color		Medida	Precio €
Farol inoxidable pared				
49440	Inox.	6	405X76	18,75

Portalámparas E27.  
Máx. 60W.



Farol inoxidable pared

49441	Inox.	6	344X142	28,50
-------	-------	---	---------	-------

Portalámparas E27.  
Máx. 60W.



Farol inoxidable pie

49442	Inox.	6	325X110	22,45
-------	-------	---	---------	-------

Portalámparas E27.  
Máx. 60W.



Farol inoxidable pie

49443	Inox.	6	500X110	27,45
-------	-------	---	---------	-------

Portalámparas E27.  
Máx. 60W.





Farol inoxidable pie

49444	Inox.	6	800X110	40,60
-------	-------	---	---------	-------

Portalámparas E27.  
Máx. 60W.  
IP44.

**NETO**  
**16,90€**

Homologadas:



1900mm.

Farol inoxidable 3 brazos

HL258P	Inox.	6	500X1900	246,60
--------	-------	---	----------	--------

- Portalámparas E27.  
- Máx. 60W.  
- IP44.

**NETO**  
**99,90€**



Código	Color		Medida	Precio €
Aplique pared inoxidable				
49497	Inox.	6	100X315	26,20

- Portalámparas E27.
- Máx. 75W.
- IP44.

**NETO  
10,90€**

Aplique pared inoxidable

49498	Inox.	6	100X315	26,20
-------	-------	---	---------	-------

- Portalámparas E27.
- Máx. 75W.
- IP44.

**NETO  
10,90€**

Aplique pared led 1,8W 6000K

46071		18		42,45
-------	--	----	--	-------

- Medida exterior: Alto:138 Ancho: 140mm
- Medida interior: Alto: 128mm Profundo: 87mm
- Lumenes: 105
- IP54

**NETO  
19,90€**

Aplique pared 18 led 1,8W 6000K

46072		18		56,90
-------	--	----	--	-------

- Medida exterior: Alto:234 Ancho: 140mm
- Medida interior: Alto: 224mm Profundo: 87mm
- Lumenes: 105
- IP54

**NETO  
25,90€**

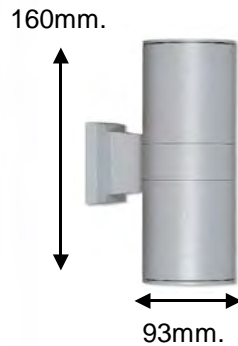
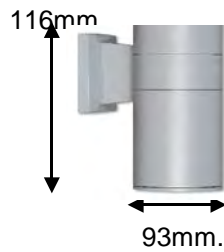

Código	Color		Precio €
<b>Aplique pared 1 luz</b>			
49437	Acero	10	<b>24,90</b>

- Portalámparas GU10.
- Lámpara GU10 máx. 35W.
- Halógena.
- Cuerpo en acero inox.
- Lámparas no incluidas.

**netos  
9,90€**

<b>Aplique pared 2 luces</b>			
49438	Acero	10	<b>36,80</b>

- Portalámparas 2 x GU10.
- Lámpara GU10 máx. 35W.
- Halógena.
- Cuerpo en acero inox.
- Lámparas no incluidas.

**netos  
14,90€**

<b>Aplique 7W SMD LED IP20</b>				
77819	Blanco	10	4200K	<b>17,90</b>
77684	Blanco	10	6000K	<b>17,90</b>

- Cuerpo ABS.
- Medidas: Ø 85mm, fondo: 77mm.
- Medida corte: 60mm.
- IP20.
- Lumen: 580 lm.
- Oscilable.

**netos  
7,90€**

<b>Aplique 6W COB LED 4200K IP65</b>				
46025	Blanco	10	4200K	<b>22,90</b>

- Medidas: Ø 90mm, fondo: 61mm.
- Medida corte: 80mm.
- IP65.
- Lumen: 410 lm.

**netos  
10,65€**

## APLIQUES EN ALUMINIO PARA USO EXTERIOR



**DOBLE LUZ**



Código	Modelo		Precio €
Aplique pared led 5,5W 220-240V / 50-60Hz.			
42801	245mm.	8	<b>52,80</b>

- IP44 Color Negro
- Luz: 4100K - 385 lúmenes.
- Medida: 245X125X65mm.

**LED  
5,5W**

**netos  
24,90€**

Aplique pared led 5,5W 220-240V / 50-60Hz.

42802	300mm.	12	<b>52,80</b>
-------	--------	----	--------------

- IP44 Color Negro
- Luz: 4100K - 420 lúmenes.
- Medida: 300X90X65mm.

**LED  
3,5W**

**netos  
24,90€**

Aplique pared led 3W 220-240V / 50-60Hz.

42804	300mm.	12	<b>47,80</b>
-------	--------	----	--------------

- IP44 Color Negro
- Luz: 4100K - 230 lúmenes.
- Medida: 300X80X70mm.

**LED  
3,5W**

**netos  
22,90€**



## APLIQUES EN ALUMINIO PARA USO EXTERIOR



Código	Modelo		Precio €
Aplicque pared led 5,5W 220-240V / 50-60Hz.			
42805	205mm.	12	69,80

- IP44 Color Negro
- Luz: 4100K - 200 lúmenes.
- Medida: 205X73mm.

**LED**  
**5,5W**

**4 LUCES**

**Netos**  
**32,90€**

Aplicque pared led 3,5W 220-240V / 50-60Hz.

42807	84mm.	24	42,40
-------	-------	----	-------

- IP44 Color Negro
- Luz: 4100K - 35 lúmenes.
- Medida: 300X90X65mm.

**LED**  
**3,5W**

**DOBLE LUZ**

**Netos**  
**18,90€**

Aplicque pared led 3W 220-240V / 50-60Hz.

42808	84mm.	16	42,40
-------	-------	----	-------

- IP44 Color Negro
- Luz: 4100K - 65 lúmenes.
- Medida: 84X170X130mm.

**LED**  
**3,5W**

**DOBLE LUZ**

**Netos**  
**19,90€**



Código	Color		Precio €	Precio Oferta
--------	-------	---	----------	---------------

#### Pica solar LED

49424		24	5,90	2,75
-------	--	----	------	------

- Carcasa ABS
- Medidas altura: 405x116 mm.
- IP clase III 45.
- 1 Batería recargable.
- Interruptor crepuscular (se enciende solo por la noche).
- Autonomía con sol de 6 a 8 horas.

#### Pica solar LED

49425		12	12,90	5,90
-------	--	----	-------	------

- Estructura inox y campana de cristal
- Medidas altura: 390x135 mm.
- IP clase III 45.
- 1 Batería recargable.
- Interruptor crepuscular (se enciende solo por la noche).
- Autonomía con sol de 6 a 8 horas.

#### Pica solar LED

49423		12	12,90	5,90
-------	--	----	-------	------

- Estructura inox y campana de cristal
- Medidas altura: 4720x140 mm.
- IP clase III 45.
- 1 Batería recargable.
- Interruptor crepuscular (se enciende solo por la noche).
- Autonomía con sol de 6 a 8 horas.

#### Pica solar LED

49428		12	8,60	3,90
-------	--	----	------	------

- Estructura inox y campana de cristal
- Medidas altura: 383x115 mm.
- IP clase III 45.
- 1 Batería recargable.
- Interruptor crepuscular (se enciende solo por la noche).
- Autonomía con sol de 6 a 8 horas.





Código	Color		Precio €	Precio Oferta
Set 5 Picas solares LED				
49426		6	15,60	6,90

- Carcasa ABS
- Medidas altura: 365x47 mm.
- IP clase III 45.
- 1 Batería recargable.
- Interruptor crepuscular (se enciende solo por la noche).
- Autonomía con sol de 6 a 8 horas.



SET DE  
5 PZAS.

**Netos  
6,90€**



Set 5 Picas solares LED				
49427		6	22,10	9,80

- Estructura inox y campana de cristal
- Medidas altura: 369x76 mm.
- IP clase III 45.
- 1 Batería recargable.
- Interruptor crepuscular (se enciende solo por la noche).
- Autonomía con sol de 6 a 8 horas.

SET DE  
5 PZAS.

**Netos  
9,80€**



**LED  
3,5W**



**LED  
5W**



**LED  
16W**

Código	Modelo		Precio €
--------	--------	---	----------

Pica de Led **3,5W** 220-240V / 50-60Hz.

HL283L	270mm.	6	<b>26,90</b>
--------	--------	---	--------------

- IP65 con cable 2X1.
- Luz: 6400K.
- 240 lúmenes.
- Medida: diámetro del foco 75mm.



**Netos  
8,90€**

Pica de Led **5W** 220-240V / 50-60Hz.

49421	272mm	6	<b>29,90</b>
-------	-------	---	--------------

- IP65 con cable 2X1.
- Luz: 6400K.
- 340 lúmenes.
- Medida: diámetro del foco 80mm.



**Netos  
9,90€**

Pica de Led **16W** 220-240V / 50-60Hz.

49422	310mm	6	<b>39,90</b>
-------	-------	---	--------------

- IP65 con cable 2X1.
- Luz: 6400K.
- 1097 lúmenes.



**Netos  
16,90€**



Código		Precio tarifa	Precio oferta
Aplicador solar 10LED 2W LED para pared			
49430	12	27,90	12,90

- Carcasa ABS.
- Medidas aplicador 155x65 mm.
- Medidas placa solar 110X80mm.
- IP clase III 45.
- 3 Baterías recargables.
- Interruptor crepuscular (se enciende solo por la noche).



#### Aplicador solar 15LED para pared **CON SENSOR**

4991729	24	34,95	15,90
---------	----	-------	-------

- Carcasa ABS.
- Medidas aplicador 130x80 mm.
- Medidas placa solar 175X100mm.
- IP clase III 45.
- 3 Baterías recargables.
- Autonomía con sol de 6 a 8 horas.



#### Set 3 Picas solares LED 9x0,06W

49429	6	29,60	13,90
-------	---	-------	-------

- Estructura inox y campana de cristal
- Medidas altura: 320x100 mm.
- IP clase III 45.
- 1 Batería recargable.
- Interruptor crepuscular (se enciende solo por la noche).
- Autonomía con sol de 6 a 8 horas.



#### Set 3 Picas solares LED

4922858	12	17,20	7,80
---------	----	-------	------

- Estructura inox
- Medidas altura: 800mm.
- IP clase III 45.
- 1 Batería recargable.
- Interruptor crepuscular (se enciende solo por la noche).
- Autonomía con sol de 6 a 8 horas.

## APROVECHE LA ENERGÍA SOLAR Y DEJE QUE EL SOL ILUMINE SU HOGAR

Las lámparas solares suponen la última tendencia en ahorro energético,  
además de evitarte una compleja instalación



# FAROLILLOS SOLARES



Código	Color		Precio €	Oferta
Farol con célula solar				
4952783		24	3,20	0,99

- IP Clase II 54.
- Baterías recargables.
- Interruptor ON-OFF.
- Interruptor crepuscular (se enciende por la noche).
- Medidas del farol: 8 mm. Altura: 25,5 mm con la pica.

**NETO**  
**0,99€**



Baliza de acero inox. 280mm.

4998947		24	6,20	2,45
---------	--	----	------	------

- Carcasa de acero inoxidable.
- IP Clase II 54.
- Baterías recargables.
- Autonomía con sol de 6 a 8 horas.
- Interruptor crepuscular (se enciende por la noche).

**NETO**  
**2,45€**



Baliza de acero inox. 365mm.

4945473	Inox.	24	4,50	1,39
---------	-------	----	------	------

- Carcasa de acero inoxidable.
- IP Clase II 54.
- Baterías recargables.
- Autonomía con sol de 6 a 8 horas.
- Interruptor crepuscular (se enciende por la noche).

**NETO**  
**1,39€**



Código	Color		Precio €	Oferta
Baliza de acero inox. 360mm.				
4916017	Inox.	12	3,95	1,80



Baliza de acero inox. 550mm.				
4951698	Inox.	24	7,80	3,60



Baliza de acero inox. 560mm.				
4989643	Inox.	12	10,90	4,95

Baliza de acero inox. 900mm.				
4989642	Inox.	6	18,70	8,50





neto  
5,99€

Código	Color		Precio €
4922856		EXP 9	14,40

- Estructura inox y campana de cristal
- Medidas altura: 550x110 mm.
- IP clase III 45.
- 1 Batería recargable.
- Interruptor crepuscular (se enciende solo por la noche).
- Autonomía con sol de 6 a 8 horas.

## LUZ BLANCA + COLORES



neto  
1,25€

Luz solar 1 led flor Altura 33 cm.

4992152		EXP 24	3,30
---------	--	--------	------



neto  
1,25€

Luz solar 1 led tulipa Altura 33 cm.

4992154		exp 24	3,30
---------	--	--------	------





Código			Precio tarifa	Precio oferta
Luz solar gnomo 1 led. Altura 15 cm.				
4948644		24 surt	<b>11,90</b>	<b>4,50</b>

- Baterías recargables.
- Interruptor crepuscular (se enciende por la noche).
- Autonomía con sol de 6 a 8 horas.



Lámpara solar gnomo led				
4979827	surtidos	12 surt.	<b>23,90</b>	<b>8,60</b>

- Medidas altura: 290 mm.
- IP Clase II 54.
- Baterías recargables.
- Interruptor crepuscular (se enciende por la noche).
- Autonomía con sol de 6 a 8 horas.



Luz solar búho 1 led. Altura 19 cm.				
4979192		24	<b>18,50</b>	<b>7,90</b>

# EXPOSITOR DE CABLE EN CARRETE

60050	1 carrete 100 mts.
60607	1 carrete 100 mts.
60608	1 carrete 100 mts.
60609	1 carrete 100 mts.
60610	1 carrete 100 mts.
60611	1 carrete 100 mts.
60612	1 carrete 100 mts.
60620	1 carrete 100 mts.
60621	1 carrete 100 mts.
60622	1 carrete 100 mts.
60623	1 carrete 100 mts.
60625	1 carrete 100 mts.
60626	1 carrete 100 mts.
60627	1 carrete 100 mts.
61063	1 carrete 100 mts.
61150	1 carrete 100 mts.



COD-EXP. 98013  
VACIO 70€

Por  
la compra  
de esta  
composición,  
Obsequio  
del expositor

Manguera blanca flexible de PVC H05VV-F<HAR>			
62027	2x1'5	Blanca	250
62076	3x1'5	Blanca	200
62084	3x2'5	Blanca	150

Manguera acrílica flexible de XLPE/PVC VV-K 0'6/1KV			
64027	2x1'5	Negra	250
64076	3x1'5	Negra	200
64084	3x2'5	Negra	150

Coaxial			
60050	SAT 1Al	Blanco	200

Paralelos			
60620	2x1	Blanco	200
60621	2x1	Rj/Ng	200
60622	2x1	Transp.	200
60625	2x1'5	Blanco	200



COD-EXP. 98015  
VACIO 150€

Por  
la compra  
de esta  
composición,  
Obsequio  
del expositor

Medidas:  
208,5x61x49 cm

**DESCUENTO MÁXIMO DEL 45%**



**60042    60050    60051**

Impedancia 75 oh.    75 oh.    75 oh.  
Inmunidad 58 dB    80 dB    80 dB



**60042**  
Conductor interior Cu. 1mm  
Aislamiento 5 mm  
Material Celular P.E.  
Apantallamiento 64 X 0,12mm  
Material Cu  
Blindaje Al. 18 X 0,04 X 2F  
Cubierta en PVC 7.5mm.

**60050-60051**

Stl.Cu.1mm.  
4,8mm.  
P.E.E.    P.E.E.  
48 X 0,12mm.  
Al. Mg.  
Al. 18 X 0,04 X 2F  
7,2mm

Código	Sección 	Color	Presen.	mts.	Precio €
<b>Coaxiales</b>					
60042	GOLD.SAT 1Cu	Blanco	Rollo	4X100	0,82
60050	H.Q.SAT 1AI	Blanco	Carret	2X100	0,38
60051	H.Q.SAT 1AI	Blanco	Caja	4X100	0,36

Código	Sección 	Color	Presen.	mts.	Precio €
--------	---	-------	---------	------	----------

<b>Paralelos</b>					
60606	2X0'50	Negro	Carrete	100	0,26
60607	2X0'50	Blanco	Carrete	100	0,26
60608	2X0'50	Rj/Ng	Carrete	100	0,26
60609	2X0'50	Transp.	Carrete	100	0,26
60610	2X0'75	Blanco	Carrete	100	0,35
60611	2X0'75	Rj/Ng	Carrete	100	0,35
60612	2X0'75	Transp.	Carrete	100	0,35
60613	2X0'75	Negro	Carrete	100	0,35
60620	2X1	Blanco	Carrete	100	0,42
60621	2X1	Rj/Ng	Carrete	100	0,42
60622	2X1	Transp.	Carrete	100	0,42
60623	2X1	Negro	Carrete	100	0,42
60625	2X1'5	Blanco	Carrete	100	0,60
60626	2X1'5	Rj/Ng	Carrete	100	0,60
60627	2X1'5	Transp.	Carrete	100	0,60
60628	2X1'5	Negro	Carrete	100	0,60

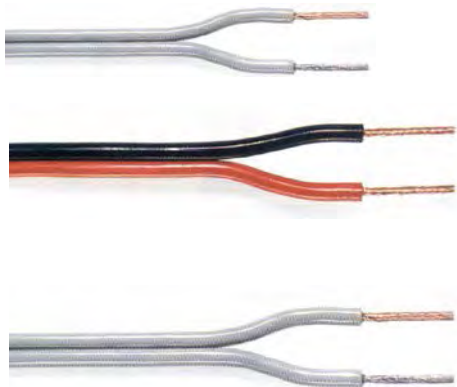

**Cables planos telefónicos**

61053	4 hilos	Blanco	Rollo	100	0,24
61063	4 hilos	Marfil	Rollo	100	0,24
61073	4 hilos	Negro	Rollo	100	0,24

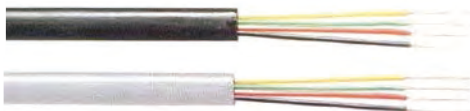

**Cables telefónicos**

61150	red. 2 hilos rígido	Marfil	Rollo	100	0,32
6124340	red. 2 hilos rígido	Marfil	Carrete	250	0,32
6124335	red. 4 hilos rígido	Marfil	Carrete	100	0,53



# CONDUCTORES TARIFA

## mangueras flexibles de pvc planas

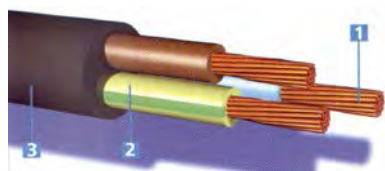
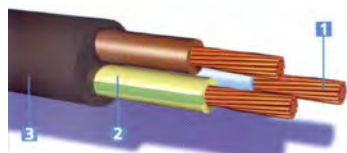
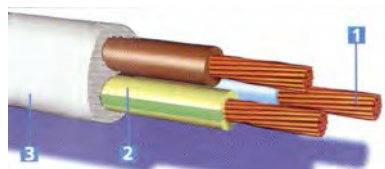
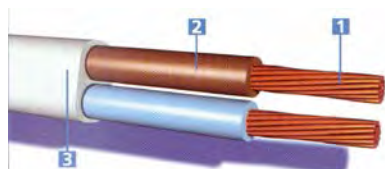

Código	Medida	Color	Presentación	Mts.	Precio
62511	2X0'75	Blanca	RETRACT.	100	<b>0,62</b>
62521	2X1	Blanca	RETRACT.	100	<b>0,79</b>
62523	2X1	Negra	RETRACT.	100	<b>0,79</b>
62525	3X1	Blanca	RETRACT.	100	<b>1,08</b>

### Mangueras blancas flexible de PVC H05VV-F <HAR>

62009	2X0'75	Blanca	RETRACT.	100	<b>0,56</b>
62018	2X1	Blanca	RETRACT.	100	<b>0,73</b>
62026	2X1'5	Blanca	RETRACT.	100	<b>0,99</b>
62034	2X2'5	Blanca	RETRACT.	100	<b>1,62</b>
62067	3X1	Blanca	RETRACT.	100	<b>0,97</b>
62075	3X1'5	Blanca	RETRACT.	100	<b>1,38</b>
62083	3X2'5	Blanca	RETRACT.	100	<b>2,22</b>
62380	4X1'5	Blanca	RETRACT.	100	<b>1,85</b>
62398	4X2'5	Blanca	RETRACT.	100	<b>2,92</b>

### Mangueras negras extraflex. de PVC/NITRI. VV-K 300/500V

64018	2X1	Negra	RETRACT.	100	<b>0,74</b>
64067	3X1	Negra	RETRACT.	100	<b>0,99</b>
64124	4X1	Negra	RETRACT.	100	<b>1,35</b>
64146	5X1	Negra	RETRACT.	100	<b>1,69</b>
64150	7X1	Negra	RETRACT.	100	<b>2,98</b>

### Manguera acrílica flexible de XLPE/PVC VV-K 0'6/1KV

64026	2X1'5	Negra	RETRACT.	100	<b>1,10</b>
64034	2X2'5	Negra	RETRACT.	100	<b>1,64</b>
64042	2X4	Negra	RETRACT.	100	<b>2,46</b>
64039	2X6	Negra	RETRACT.	100	<b>3,47</b>
64075	3X1'5	Negra	RETRACT.	100	<b>1,40</b>
64083	3X2'5	Negra	RETRACT.	100	<b>2,27</b>
64091	3X4	Negra	RETRACT.	100	<b>3,42</b>
64094	3X6	Negra	RETRACT.	100	<b>5,05</b>
64125	4X1'5	Negra	RETRACT.	100	<b>1,90</b>
64133	4X2'5	Negra	RETRACT.	100	<b>2,92</b>
64145	4X4	Negra	RETRACT.	100	<b>4,52</b>
64144	4X6	Negra	RETRACT.	100	<b>6,46</b>
64147	5X1'5	Negra	RETRACT.	100	<b>2,39</b>
64148	5X2'5	Negra	RETRACT.	100	<b>3,70</b>
64149	5X4	Negra	RETRACT.	100	<b>5,43</b>
64005	1X25	Negra	RETRACT.	50	<b>6,40</b>
64006	1X35	Negra	RETRACT.	50	<b>8,80</b>

## CONDUCTORES DE CARRETE

**CÓDIGO MEDIDA COLOR PRESENTACIÓN MTS. PRECIO**

Mangueras blancas flexible de PVC H05VV-F <HAR>

62019	2X1	Blanca	CARRETE	300	<b>0,83</b>
62027	2X1'5	Blanca	CARRETE	250	<b>1,12</b>
62068	3X1	Blanca	CARRETE	250	<b>1,08</b>
62076	3X1'5	Blanca	CARRETE	200	<b>1,52</b>
62084	3X2'5	Blanca	CARRETE	150	<b>2,40</b>

Manguera acrílica flexible de XLPE/PVC VV-K 0'6/1KV

64019	2X1	Negra	CARRETE	300	<b>0,83</b>
64027	2X1'5	Negra	CARRETE	250	<b>1,22</b>
64068	3X1	Negra	CARRETE	250	<b>1,12</b>
64076	3X1'5	Negra	CARRETE	200	<b>1,54</b>
64084	3X2'5	Negra	CARRETE	150	<b>2,45</b>
64126	4X1,5	Negra	CARRETE	150	<b>2,10</b>
64134	4X2,5	Negra	CARRETE	100	<b>3,20</b>

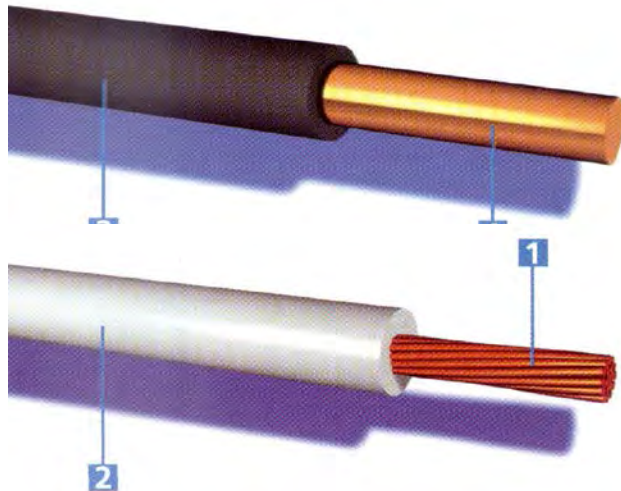
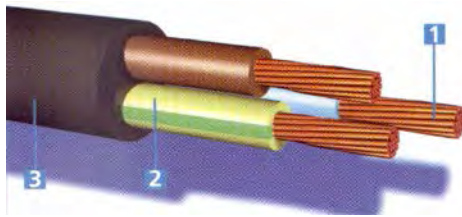
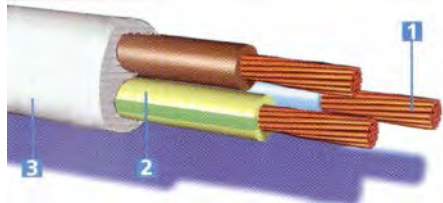

## HILO DE LÍNEA RÍGIDO Y FLEXIBLE

### Características técnicas:

Cables unipolares rígidos y flexibles aislados con PVC extradeslizante para instalaciones domésticas y luminarias hasta 750V.

- \* Constante de aislamiento (ki); 37.
- \* No propagador de la llama (UNE 20432-1).
- \* Temperatura de servicio 70° C.
- \* Extradeslizante.
- \* Temperatura máxima cortocircuito 160°C.
- \* UNE <HAR> 21031-(HD21).1 S2.

- 1 Conductor de cobre electrolítico clase V.
- 2 Aislante de policloruro de vinilo del tipo T11.

### COLORES

Sección					Tierra	Present.	Unidad venta	Precio €
---------	--	--	--	--	--------	----------	--------------	----------

Hilo de línea unipolar flexible aislado con PVC extradeslizante UNE 21031 <HAR>

	63800	63801	63802	63803	63804	<b>RETRÁCTIL</b>	100	<b>0,36</b>
1'5 mm	63820	63821	63822	63823	63824	CAJA	200	<b>0,36</b>
2'5 mm	63830	63831	63832	63833	63834	CAJA	100	<b>0,59</b>
4 mm	63840	63841	63842	63843	63844	CAJA	100	<b>1,02</b>
6 mm	63850	63851	63852	63853	63854	CAJA	100	<b>1,42</b>

**Hilo de línea unipolar flexible aislado con PVC extradeslizante UNE 21031 <HAR>**

### COLORES

Sección					Tierra	Present.	Unidad venta	Precio €
---------	--	--	--	--	--------	----------	--------------	----------

1'5 mm	63810	63811	63812	63813	63814	<b>CARRETE</b>	800	<b>0,40</b>
2'5 mm	63835	63836	63837	63838	63839	<b>CARRETE</b>	600	<b>0,64</b>

## MANGUERA RZ1-K (AS) ALTA SEGURIDAD

**LIBRE DE HALÓGENOS**

- UNE-21123-4.
- Tensión nominal 0,6/1KV.
- Conductor CU. CLASE 5.
- Aislamiento tipo XLPE.
- Cubierta poliolefina (verde)
- Libre de halógenos (Cable ignífugo)



Código	Medida	Color	Presentación	Mt.	Precio
64260	2X1'5	Verde	Rollo	100	<b>1,20</b>
64261	2X2'5	Verde	Rollo	100	<b>1,84</b>
64270	3X1'5	Verde	Rollo	100	<b>1,66</b>
64271	3X2'5	Verde	Rollo	100	<b>2,46</b>
64280	4X1'5	Verde	Rollo	100	<b>2,24</b>
64281	4X2'5	Verde	Rollo	100	<b>3,21</b>
64290	5X1'5	Verde	Rollo	100	<b>2,64</b>

## HILO DE LÍNEA RÍGIDO Y FLEXIBLE LIBRE DE HALÓGENOS TIPO-ES 07Z1-K

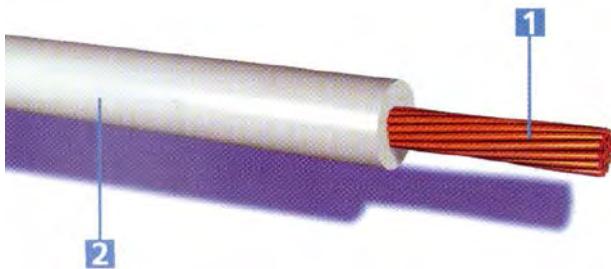

### Características técnicas:

- Cables unipolares flexibles aislados con XLPE.
- Conductor de CU clase 5.
- No propagador de la llama (UNE 20432-1)
- Temperatura de servicio 70° C
- Resistencia a la humedad
- Extradreslizante
- Temperatura máxima cortocircuito 160°C
- UNE <HAR> 21031-(HD21).1 S2
- 1 Conductor de Cu electrolítico clase 5.2 Aislante de policloruro de vinilo del tipo T11.

SECCIÓN	COLORES				TIERRA	PRESENT.	UNIDAD VENTA	PRECIO €

### HILO DE LÍNEA UNIPOLAR FLEXIBLE AISLADO CON PVC EXTRADESLIZANTE UNE 21031 <HAR> LIBRE DE HALÓGENOS

1'5 mm	63941	63942	63943	63944	63945	CAJA	200	<b>0,39</b>
2'5 mm	63951	63952	63953	63954	63955	CAJA	100	<b>0,64</b>
4 mm	63961	63962	63963	63964	63965	CAJA	100	<b>1,02</b>
6 mm	63971	63972	63973	63974	63975	CAJA	100	<b>1,51</b>

Tubo coarrugado fabricado en PVC-U no propagador de la llama. Color gris RAL 7035. Características según Norma UNE 50086 2-2. Resistencia compresión 320 n. Resistencia al impacto 1J ( a -5°C). Temperatura de utilización -5°C, +60°C Curvable. Código clasificación: 23212042010. Grado de protección 7 según UNE 20.324 (3ª cifra características). Influencias externas IP42.



#### COARRUGADO GRIS ATUPLAS

Diámetro	Medida	Código	Present.	Precio X metro	
16	100	65011	ROLLO	0,28	1
20	100	65013	ROLLO	0,36	1
25	75	65017	ROLLO	0,51	1
32	50	65023	ROLLO	0,74	1
40	25	65029	ROLLO	0,94	1

Tubo coarrugado forrado fabricado en PVC-U no propagador de la llama. Color gris RAL 7035. Características según Norma UNE 50086 2-2. Resistencia compresión 320 n. Resistencia al impacto 2J ( a -5°C). Temperatura de utilización -5°C +60°C Curvable. Código clasificación: 22212042010. Grado de protección 7 según UNE 20.324 (3ª cifra características). Influencias externas IP42.



#### COARRUGADO GRIS REFLEX

Diámetro	Medida	Código	Present.	Precio X metro	
16	100	65061	ROLLO	0,58	1
20	100	65063	ROLLO	0,66	1
25	75	65067	ROLLO	0,85	1
32	50	65073	ROLLO	1,34	1
40	25	65079	ROLLO	2,50	1

#### COARRUGADO GRIS ATUPLAS ROLLITOS

Diámetro	Medida	Código	Present.	Precio X metro	
16	10	65110	ROLLO	5,30	10
16	15	65115	ROLLO	6,80	8
16	25	65125	ROLLO	9,60	6
20	10	65310	ROLLO	5,90	10
20	15	65315	ROLLO	7,40	6
20	25	65325	ROLLO	11,10	4
25	10	65610	ROLLO	7,40	14
25	15	65615	ROLLO	9,80	8
25	25	65625	ROLLO	14,70	6
32	10	65710	ROLLO	9,80	6
32	15	65715	ROLLO	13,60	6
32	25	65725	ROLLO	21,40	4



Las medidas son en métrica y diámetro exterior según marca la norma UNE -EN 60423.



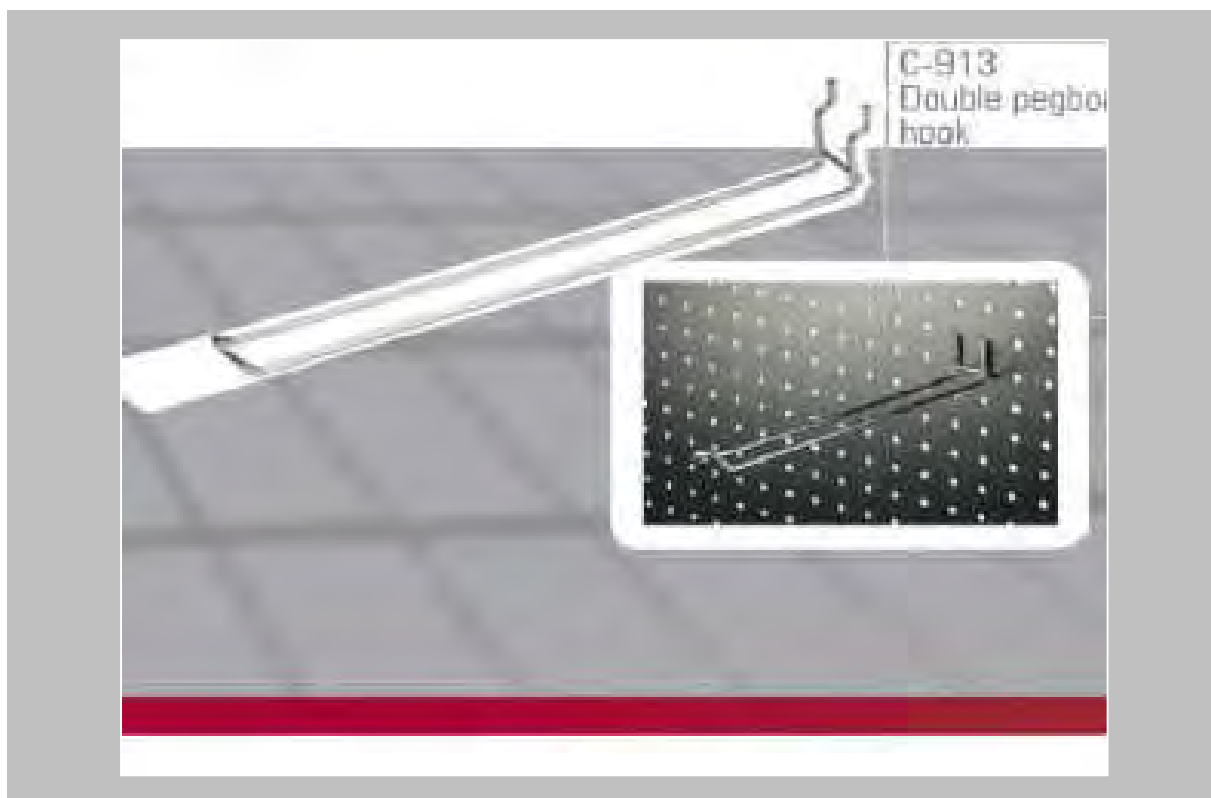

Código	Medida	Precio neto
98032	30 cm.	1,40

Cajas de 50

**Gancho universal estanterías ranuradas  
doble de 4 mm.**



Código	Medida	Precio neto
98034	30 cm.	1,40

Cajas de 50

**Gancho universal estanterías ranuradas  
sencillo de 6 mm.**

